



OPERATING MANUAL

MODEL 4140A

pA METER/DC VOLTAGE SOURCE

(including Options 001 and 101)

SERIAL NUMBERS

This manual applies directly to instruments with serial numbers prefixed 1917J

For additional important information about serial numbers, see INSTRUMENTS COVERED BY MANUAL in Section I.

COPYRIGHT: YOKOGAWA-HEWLETT-PACKARD, LTD., 1979
9-1, TAKAKURA-CHO, HACHIOJI-SHI, TOKYO, JAPAN

TABLE OF CONTENTS

| Section | Title | Page | Section | Title | Page |
|---------|--|------|---------|------------------------------|------|
| I | GENERAL INFORMATION | 1-1 | 3-29. | VS Section Display | 3-14 |
| | 1-1. Introduction | 1-1 | 3-31. | VS Section Output Modes .. | 3-14 |
| | 1-4. Description | 1-1 | 3-33. | VS Section | |
| | 1-9. Specification | 1-2 | | Operating Parameters ... | 3-15 |
| | 1-11. Safety Considerations | 1-2 | 3-35. | Voltage Output | |
| | 1-14. Instruments | | | and Display of VS | 3-16 |
| | Covered by Manual | 1-3 | 3-37. | Output Voltage Range | 3-19 |
| | 1-19. Options..... | 1-13 | 3-39. | Current Limit | 3-19 |
| | 1-21. Option 001 Analog Out | 1-13 | 3-41. | VS Section | |
| | 1-23. Option 101 HP-IB Interface | 1-13 | | Operating Instructions . | 3-19 |
| | 1-25. Option 907, 908 or 909 | 1-13 | 3-43. | I-V Measurement | 3-22 |
| | 1-27. Option 910 Extra Manual ... | 1-13 | 3-45. | I-V Measurement | |
| | 1-29. Accessories Supplied | 1-13 | | Data Output | 3-22 |
| | 1-31. Accessories Available | 1-13 | 3-47. | I-V Measurement | |
| | | | | Operating Instructions . | 3-25 |
| II | INSTALLATION | 2-1 | 3-49. | C-V Measurement | 3-29 |
| | 2-1. Introduction | 2-1 | 3-51. | C-V Measurement | |
| | 2-3. Initial Inspection | 2-1 | | Data Output | 3-29 |
| | 2-5. Preparation for Use | 2-1 | 3-53. | C-V Measurement Range | 3-29 |
| | 2-6. Power Requirements | 2-1 | 3-55. | C-V Measurement | |
| | 2-8. Line Voltage Selection | 2-1 | | Zero Offset | 3-32 |
| | 2-10. Power Cable | 2-3 | 3-57. | C-V Measurement | |
| | 2-12. Operating Environment | 2-3 | | in Percent | 3-33 |
| | 2-15. Installation Instructions .. | 2-3 | 3-59. | C-V Measurement | |
| | 2-17. Installation of | | | Operating Instructions . | 3-33 |
| | Options 907, 908 and 909.. | 2-3 | 3-61. | Annunciations | 3-41 |
| | 2-19. Storage and Shipment | 2-4 | 3-63. | Option Operation | 3-43 |
| | 2-20. Environment | 2-4 | 3-65. | Option 001 Analog Output ... | 3-43 |
| | 2-22. Packaging | 2-4 | 3-67. | Control Capabilities for | |
| | 2-25. Option Installation | 2-4 | | Option 001 Analog Output | 3-43 |
| III | OPERATION | 3-1 | 3-69. | Option 101 HP-IB Interface . | 3-46 |
| | 3-1. Introduction | 3-1 | 3-71. | Connection to HP-IB | 3-46 |
| | 3-3. Panel Features | 3-1 | 3-73. | HP-IB Status Indicators .. | 3-46 |
| | 3-5. Self Test | 3-1 | 3-75. | Local Key | 3-46 |
| | 3-8. Initial Control Settings | 3-8 | 3-77. | HP-IB Control Switch | 3-46 |
| | 3-10. Measurement Function | 3-8 | 3-79. | HP-IB Interface | |
| | 3-12. pA (Pico-Ampere) Meter | | | Capabilities of | |
| | Section | 3-9 | | 4140A Opt. 101 | 3-47 |
| | 3-14. pA Meter Display | 3-9 | 3-81. | Remote Program Code | 3-47 |
| | 3-16. Current Measurement Ranges . | 3-9 | 3-83. | Parameter Setting | 3-50 |
| | 3-18. Integration Time | | 3-85. | Data Output | 3-50 |
| | and Data Output | 3-10 | 3-87. | I.C Measurement Value and | |
| | 3-21. External Triggering | 3-10 | | VA Output Voltage | 3-51 |
| | 3-23. Zero Offset for | | 3-89. | Parameter Output | 3-51 |
| | Current Measurement | 3-10 | 3-91. | Key Status Data | 3-51 |
| | 3-25. pA Meter | | 3-93. | Service Request | |
| | Operating Instructions .. | 3-11 | | Status Byte | 3-52 |
| | 3-27. VS (Voltage Source) Section . | 3-14 | 3-95. | High Speed I (HSI) | |
| | | | | Function | 3-52 |
| | | | 3-97. | Programming Guide | |
| | | | | for 4140A | 3-54 |

TABLE OF CONTENTS

| Section | Title | Page |
|---------|--|------|
| IV | PERFORMANCE TESTS | 4-1 |
| 4-1. | Introduction | 4-1 |
| 4-3. | Equipment Required | 4-1 |
| 4-5. | Test Record | 4-1 |
| 4-7. | Calibration Cycle | 4-1 |
| 4-9. | Auto Setting Mode | 4-1 |
| 4-11. | Voltage Output Accuracy Test | 4-4 |
| 4-13. | Current Measurement Accuracy Test | 4-6 |
| 4-15. | Current Limit Test | 4-8 |
| 4-17. | Ramp Wave Start Voltage Accuracy Test | 4-10 |
| 4-19. | Ramp Rate Accuracy Test | 4-12 |
| 4-21. | Analog Output Accuracy Test (Option 001 Only) | 4-15 |
| 4-23. | HP-IB Interface Test (Option 101 Only) | 4-17 |









LIST OF TABLES

| Number | Title | Page | Number | Title | Page |
|--------|--|------|--------|--|------|
| 1-1. | Specifications | 1-4 | 3-9. | Analog Output Data at V _A OUTPUT Connector | 3-43 |
| 1-2. | General Information | 1-11 | 3-10. | X-Y Recorder Pen Position Control | 3-44 |
| 1-3. | Available Options | 1-13 | 3-11. | HP-IB Interface Capabilities | 3-47 |
| 1-4. | Accessories Available | 1-14 | 3-12. | Remote Program Code | 3-47 |
| 1-5. | Application Ranges of Accessories | 1-13 | 3-13. | Program Code for Parameter Setting | 3-50 |
| 2-1. | Option Installation | 2-4 | 3-14. | Accuracy and Data Output Interval in HSI Function . | 3-53 |
| 3-1. | Automatic Control Settings ... | 3-8 | 3-15. | Sample Program Using HP 9825A or 9835A Calculator | 3-54 |
| 3-2. | Current Measurement Integration Time | 3-10 | 4-1. | Recommended Performance Test Equipment | 4-2 |
| 3-3. | VS Section Output Modes | 3-14 | 4-2. | Auto Setting Modes for Performance Tests and Adjustments | 4-3 |
| 3-4. | VS Section Operating Parameters | 3-15 | 4-3. | Output Voltage Accuracy Test | 4-5 |
| 3-5. | Inhibition of Controls and Operating Parameters (when VS Section is Operating) | 3-16 | 4-4. | Current Measurement Accuracy Test | 4-7 |
| 3-6. | C-V Measurement Accuracy | 3-33 | | | |
| 3-7. | 4140A Annunciations | 3-41 | | | |
| 3-8. | Analog Output Data at I/C OUTPUT Connector | 3-43 | | | |

LIST OF TABLES

| Number | Title | Page | Number | Title | Page |
|--------|--|------|--------|---|------|
| 4-5. | Current Limit Test | 4-9 | 4-13. | Controller Instructions and Operator Responses for Test Program 4 | 4-25 |
| 4-6. | Ramp Wave Start Voltage Accuracy Test | 4-11 | 4-14. | Controller Instructions and Operator Responses for Test Program 5 | 4-27 |
| 4-7. | Controller Instructions and Operator Responses for Ramp Rate Accuracy Test Program | 4-14 | | | |
| 4-8. | Ramp Rate Accuracy Test | 4-14 | | | |
| 4-9. | Analog Output Accuracy Test . | 4-16 | | | |
| 4-10. | Controller Instructions and Operator Responses for Test Program 1 | 4-19 | | | |
| 4-11. | Controller Instructions and Operator Responses for Test Program 2 | 4-21 | | | |
| 4-12. | Controller Instructions and Operator Responses for Test Program 3 | 4-23 | | | |

LIST OF ILLUSTRATIONS

| Number | Title | Page | Number | Title | Page |
|--------|---|------|--------|--|------|
| 1-1. | Model 4140A and Supplied Accessories | 1-1 | 3-9. | Relationship between Output Voltage and Display for  (Single Ramp Wave) | 3-18 |
| 2-1. | Line Voltage and Fuse Selection | 2-1 | 3-10. | Relationship between Output Voltage and Display for  (Double Ramp Wave) | 3-18 |
| 2-2. | Power Cables Supplied | 2-2 | 3-11. | Output Voltage Range of Staircase Wave | 3-19 |
| 2-3. | Rack Mount Kit | 2-3 | 3-12. | VS Section Operating Instructions (when FUNCTION is Set to I) | 3-20 |
| 3-1. | Front Panel Features | 3-2 | 3-13. | Relationship between I-V Measurement and Displays for  (Single Staircase Wave) .. | 3-23 |
| 3-2. | Rear Panel Features | 3-6 | 3-14. | Relationship between I-V Measurement and Displays for  (Double Staircase Wave) . | 3-23 |
| 3-3. | Octal Codes of Control Keys .. | 3-8 | 3-15. | Relationship between I-V Measurement and Displays for  (Single Ramp Wave) | 3-24 |
| 3-4. | Less Significant Zero | 3-9 | 3-16. | Relationship between I-V Measurement and Displays for  (Double Ramp Wave) | 3-24 |
| 3-5. | Integration Time and Data Output (when FUNCTION is Set to I) | 3-11 | | | |
| 3-6. | pA Meter Section Operating Instructions (when FUNCTION is Set to I) | 3-12 | | | |
| 3-7. | Relationship between Output Voltage and Display for  (Single Staircase Wave) . | 3-17 | | | |
| 3-8. | Relationship between Output Voltage and Display for  (Double Staircase Wave) . | 3-17 | | | |

LIST OF ILLUSTRATIONS

| Number | Title | Page | Number | Title | Page |
|--------|---|------|--------|---|------|
| 3-17. | I-V Function Operating Instructions ... | 3-25 | 4-1. | Voltage Output Accuracy Test Setup | 4-4 |
| 3-18. | Relationship between C-V Measurement and Displays for ∩ (Single Ramp Wave) . | 3-30 | 4-2. | Current Measurement Accuracy Test Setup ($10^{-2}A \sim 10^{-7}A$ Ranges) | 4-6 |
| 3-19. | Relationship between C-V Measurement and Displays for ∧ (Double Ramp Wave) .. | 3-30 | 4-3. | Current Measurement Accuracy Test Setup ($10^{-8}A \sim 10^{-12}A$ Ranges) | 4-6 |
| 3-20. | Relationship between Calculated Capacitance Value and Current Measurement Range | 3-31 | 4-4. | Current Limit Test Setup | 4-8 |
| 3-21. | Suitable Current Measurement Range for C-V Measurement | 3-32 | 4-5. | Ramp Wave Start Voltage Accuracy Test Setup | 4-10 |
| 3-22. | C-V Measurement Accuracy ... | 3-34 | 4-6. | Ramp Rate Accuracy Test Setup | 4-12 |
| 3-23. | C-V Function Operating Instructions ... | 3-38 | 4-7. | Ramp Rate Accuracy Test Program Using 9835A | 4-13 |
| 3-24. | Option 001 Analog Output Operating Instructions ... | 3-44 | 4-8. | Analog Output Accuracy Test Setup | 4-15 |
| 3-25. | HP-IB Control Switch | 3-46 | 4-9. | HP-IB Interface Test Setup . | 4-17 |
| 3-26. | Status Bytes of the 4140A .. | 3-52 | 4-10. | HP-IB Interface Test Program 1 Using 9835A | 4-18 |
| 3-27. | Data Output Format of the HSI (High Speed I) Function | 3-53 | 4-11. | HP-IB Interface Test Program 2 Using 9835A | 4-20 |
| 3-28. | Sample Program 1 Using 9825A/9835A | 3-55 | 4-12. | HP-IB Interface Test Program 3 Using 9835A | 4-22 |
| 3-29. | Sample Program 2 Using 9825A/9835A | 3-56 | 4-13. | HP-IB Interface Test Program 4 Using 9835A | 4-24 |
| 3-30. | Sample Program 3 Using 9825A/9835A | 3-57 | 4-14. | HP-IB Interface Test Program 5 Using 9835A | 4-26 |
| 3-31. | Sample Program 4 Using 9825A/9835A | 3-58 | | | |
| 3-32. | Sample Program 5 Using 9825A/9835A | 3-59 | | | |

SECTION I GENERAL INFORMATION

1-1. INTRODUCTION

1-2. This Operating Manual contains the information required to install, operate and test the Hewlett-Packard Model 4140A pA Meter/DC Voltage Source. Figure 1-1 shows the instrument and supplied accessories. This section covers the instrument identification, description, options, accessories, specifications and other basic information. To order an additional manual, use the part number listed on manual title page.

1-3. Also listed on title page of manual is a microfiche part number. This number can be used to order 4 x 6 inch microfilm transparencies of the manual. Each microfiche contains up to 98 photo-duplicates of the manual pages. The microfiche package also includes the latest Manual Changes supplement as well pertinent Service Notes.

1-4. DESCRIPTION.

1-5. The HP Model 4140A pA Meter/DC Voltage Source comprises a high stability pA Meter with 10^{-15} A max. resolution coupled with two programmable DC voltage sources to ensure useability in many application areas. The pA meter of the 4140A has a basic accuracy of 0.5% over wide measurement ranges ($\pm 0.001 \times 10^{-12}$ A $\sim \pm 1900 \times 10^{-2}$ A) enabling stable pA current measurement at 10^{-15} A (± 1 count). This is achieved by a new unique, variable, digital, integration method. This stable and fast (less than 35ms at 1nA) measurement technique is very useful, not only for the measurement of the small leakage currents of semiconductor devices and the static characteristics of FET's, but also for making insulation resistance/leakage, current/absorption measurements/analyses of capacitance and insulation materials. One of the two program-

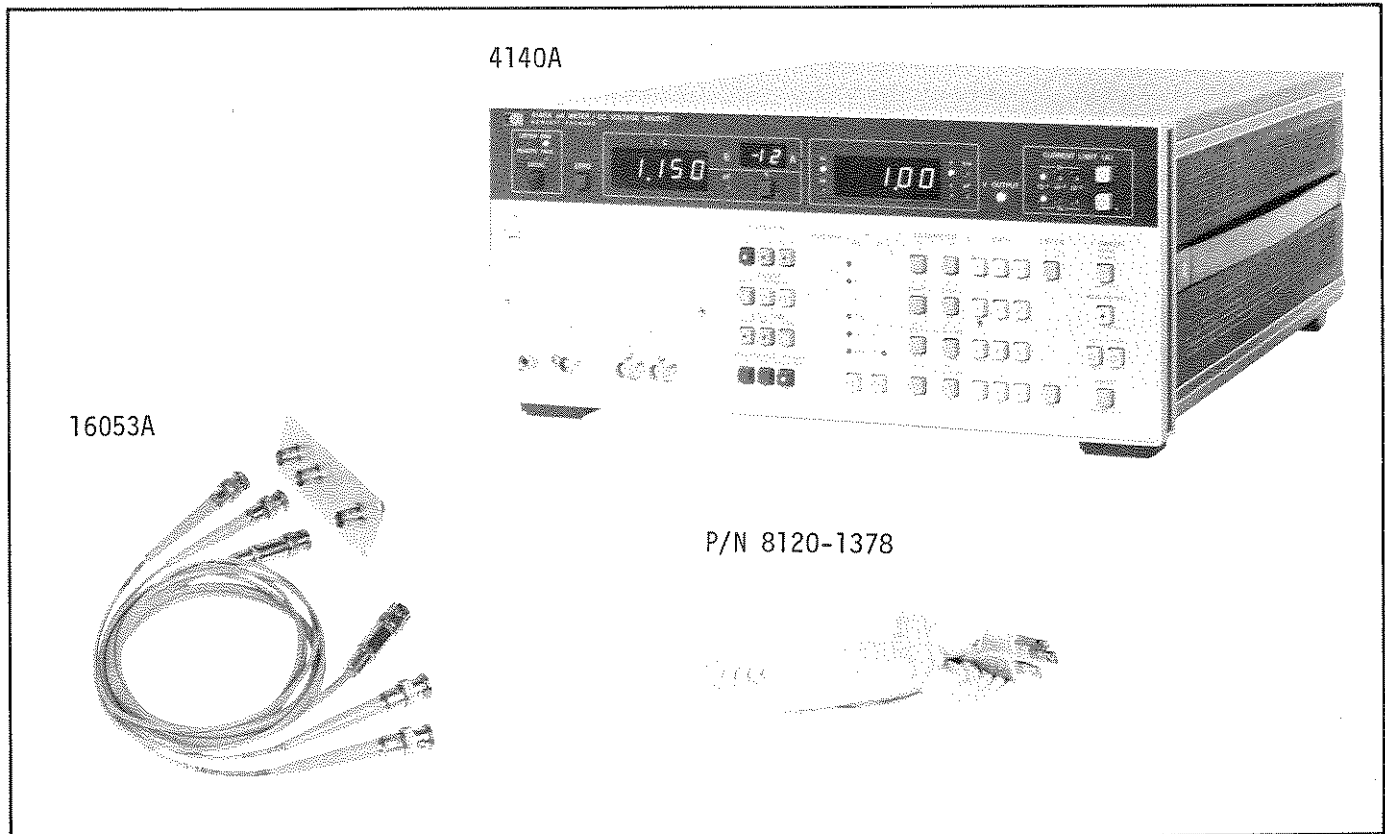







Figure 1-1. Model 4140A and Supplied Accessories.

mable DC voltage sources (V_A) of the 4140A can operate, not only as a programmable DC voltage source, but also as a unique staircase (, ) and accurate ramp (, ) generator. The DC Voltage Source has an output range of $\pm 100V$ in 100mV steps or $\pm 10V$ in 10mV steps and the ramp rate can be set from 0.001V/S to 1V/S at 0.001V/S resolution. The sweeps of the staircase and ramp functions operate, both in the AUTO sweep mode with a pause key (for changing step voltage and sweep direction during measurement) and in the MANUAL sweep mode with down () and up () keys. Each of the 4140A programmable DC voltage sources (V_A and V_B) has a current limiter to avoid damaging the DUT by excessive current.

1-6. A key capability of the 4140A is its ability to make accurate I-V/C-V measurements. Measurement timing can be automatically synchronized between the DC Voltage Source and the pA Meter section. The start, stop and step voltages can be set from -100V to +100V at 100mV resolution (from -10V to +10V at 10mV resolution). The hold/step delay time can also easily be set depending upon the characteristics of the material being tested. All these capabilities are featured in the HP 4140A itself which, up to now, has required an extensive instrument system. Static characteristics of semiconductors, diodes and FET's, the analysis of MIS construction, and the measurement of the threshold voltages of FET's in addition to 1 minute value measurements for insulation resistances (resistance values of approximately $0.5\Omega \sim 10^{17}\Omega$ can be calculated from the I-V measured values) can easily, quickly, and efficiently be made with the 4140A. With the 4140A it is especially easy to make a quasi-static C-V measurement (a capacitance measurement utilizing a ramp-wave) which is usually employed as one of the measurements when trying to improve semiconductor quality. The 4140A measures capacitance value by the following formula:

$$C = \frac{I \text{ (measured current value)}}{dV/dt \text{ (ramp rate)}}$$

This is possible with the 4140A as both the desired setting of the ramp voltage and the capacitance measurement are completely synchronized, and the calculated capacitance value (0.0 ~ 1900pF) or percent change (0.0% ~ 199.9%) VS Cox (the capacitance of oxide film) and the appropriate ramp voltage value are simultaneously displayed.

1-7. The 4140A employs certain particular functions which make the best use of the in-

telligence capability of its microprocessor. For example, its zero offset current capability cancels leakage current of test leads and fixtures and its zero offset capacitance capability cancels stray capacitances of test leads and fixtures for accurate current or capacitance measurements. The self-test capability checks ROM's RAM's, displays, indicators and control keys of the 4140A automatically when the 4140A is turned to ON or the SELF TEST front panel key is pushed. The measurement parameters of the 4140A (V_A , V_B , START V, STOP V, STEP V, HOLD TIME, dV/dt, STEP DELAY TIME and Cox) are stored in the 4140A memory and can be used repeatedly.

1-8. The Option 001 Analog Output can be used to output analog data to an X-Y Recorder and to trace I-V/C-V curves. The Option 101 HP-IB Interface is used for remote control and data output via the HP-IB. In addition, four unique accessories are available for making a wide range of universal measurements.

1-9. SPECIFICATIONS

1-10. Complete specifications of the Model 4140A pA Meter/DC Voltage Source are given in Table 1-1. These specifications are the performance standards or limits against which the instrument is tested. The test procedure for the specifications are covered in Section IV Performance Test. Table 1-2 lists general information. General information is not specifications but is typical characteristics included as additional information for the operator. When the 4140A pA Meter/DC Voltage Source is shipped from the factory, it meets the specifications listed in Table 1-1.

1-11. SAFETY CONSIDERATIONS

1-12. The Model 4140A pA Meter/DC Voltage Source has been designed to conform to the safety requirements of an IEC (International Electromechanical Committee) Safety Class I instrument (provided with a protective earth terminal) and is shipped from the factory in a safe condition.

1-13. This operating manual contains information, cautions, and warnings which must be followed by the user to ensure safe operation and to maintain the instrument in a safe condition.

1-14. INSTRUMENTS COVERED BY MANUAL.

1-15. A serial number plate is attached to the rear of the instrument. The serial number is in the form: xxxxJxxxx. It is in two parts, the first four digits and the letter are the serial prefix and the last five digits are the suffix. The prefix is the same for all identical instruments; it changes only when a change is made to the instrument. The suffix however, is assigned sequentially and is different for each instrument. The contents of this manual apply to instruments with the serial number prefix (es) listed under SERIAL NUMBERS on the title page.

1-16. An instrument manufactured after the printing of this manual may have a serial number prefix that is not listed on the title page. This unlisted serial number prefix indicates that the instrument is different from those described in this manual. The manual for this newer instrument is accompanied by a yellow Manual Changes supplement. This supplement contains "change information" that explains how to adapt the manual to the newer instrument.

1-17. In addition to change information, the supplement may contain information for correcting errors in the manual. To keep this manual as current and accurate as possible, Hewlett-Packard recommends that you periodically request the latest Manual Changes supplement. The supplement for this manual is identified with the manual print date and part number, both of which appear on the manual title page. Complimentary copies of the supplement are available from Hewlett-Packard.

1-18. For information concerning a serial number prefix that is not listed on the title page or in the Manual Changes supplement, contact your nearest Hewlett-Packard office.











Table 1-1. Specifications(sheet 1 of 7).

Measurement Functions: I-V, C-V and I

- I: For independent operations as universal pA Meter/Programmable Voltage Source
- I-V: I-V characteristic measurement using staircase/ramp wave
- C-V: Quasi-Static C-V characteristic measurement using ramp wave

Voltage Source: Two separate sources (VA and VB)

- VA: $\pm 100V$, function generator/programmable source
- VB: $\pm 100V$, programmable DC voltage source

| Function | VA | VB |
|----------|---|----|
| I-V |  ,  ,  ,  | ≡ |
| C-V |  ,  | |
| I |  ,  ,  ,  ,  | |

Voltage Sweep: Auto (pause available)/Manual

Warm-up Time: ≥ 1 hour

GENERAL

Operating Temperature: $0^{\circ}C$ to $40^{\circ}C$

Relative Humidity: $\leq 70\%$ at $40^{\circ}C$

Power: 100/120/220V $\pm 10\%$, 240V-10%+5%, 50Hz/60Hz $\pm 5\%$, max. 135VA with any option.

Dimensions: 426mmW x 177mmH x 498mmD

Weight: Approx. 14.2kg

Accessory Furnished: 16053A Test Leads (1 set)

Table 1-1. Specifications(sheet 2 of 7).

CURRENT MEASUREMENT

Display: 3-1/2 digit, 90% overrange

Measurement Range: $\pm 0.001 \times 10^{-12} \text{A} \sim \pm 1.900 \times 10^{-2} \text{A}$, 11 ranges, auto/manual range selection.

Measurement Accuracy/Integration Time:

| Range(A) | Measurement Accuracy* | Integration Time(ms)** | | |
|------------------------|-----------------------|------------------------|-----|------|
| | | SHORT | MED | LONG |
| $10^{-2} \sim 10^{-9}$ | $\pm (0.5 + 2)$ | 20 | 80 | 320 |
| 10^{-10} | $\pm (2 + 2)$ | | | |
| 10^{-11} | $\pm (5 + 3)$ | 80 | 320 | 1280 |
| 10^{-12}^{***} | $\pm (5 + 8)$ | 160 | 640 | 2560 |

* \pm (% of rdg + counts), $23^\circ\text{C} \pm 5^\circ\text{C}$, $\leq 70\%$ humidity, integration time ... LONG

** at 50Hz line frequency (x5/6 at 60Hz operation).

*** Zero offset is performed.

Voltage Burden: $\leq 10\mu\text{V}$ at full scale.Internal Electromotive force: $\leq 100\mu\text{V}$

Maximum Input (peak value):

Hi -Lo: $\pm 2\text{V}$ at $10^{-2} \sim 10^{-3} \text{A}$ range.
 $\pm 30\text{V}$ at $10^{-4} \sim 10^{-5} \text{A}$ range.
 $\pm 120\text{V}$ at $10^{-6} \sim 10^{-12} \text{A}$ range.
 Lo-Guard: $\pm 200\text{V}$.

Zero Offset: Cancels leakage current of test leads/fixtures.

Offset Ranges: $0 \sim \pm 100\text{fA}$.

Output Trigger for I Data: INT/EXT or MAN.







High Speed I Data Output (available with OPT 101 HP-IB): Outputs current measurement data with max. 2.5ms intervals. (Refer to reference data for accuracy).

Input Terminal: Trizxial BNC (HP Part No: 1250-0687).

Table 1-1. Specifications(sheet 3 of 7).

DC VOLTAGE SOURCE (VA AND VB)

Output Mode:

VA:  ,  ,  ,  ,  , OFF
 VB:  , OFF

Voltage Range: 0 ~ ±10.00V, 0 ~ ±100.0V, 2 ranges (autoranging only).

Max. Current Capacity: 10mA.

Sweep Control: Auto (pause available)/man., up/down manually available in hold.

Operating Parameters Setting Ranges:

Start/Stop/DC Voltage: 0 ~ ±10.00V in 0.01V steps, 0 ~ ±100.0V in 0.1V steps



Step Voltage: ±0.01V ~ ±10.00V in 0.01V steps (0.1V step at 10V of absolute value of output voltage)

Hold Time: 0 ~ 199.9s in 0.1s steps, 0 ~ 1999s in 1s steps.

Step Delay Time: 0 ~ 10.00s in 0.01s steps, 0 ~ 100.0s in 0.1s steps.

Ramp Rate (dV/dt): 0.001V/s ~ 1.000V/s in 0.001V/s steps.

Accuracy: at (23°C ± 5°C)

Output Voltage ( ,  , ):

±10V: ±(0.07% + 11mV).

±100V: ±(0.09% + 110mV).

Accuracy of Ramp Voltage* :

$$\text{Ramp Rate: } \pm(0.2\% + 10_{\mu}\text{V/s}) - \frac{10^{-5} \times \text{START Voltage (V)}}{\text{HOLD TIME (s)} + 2\text{s}}$$

$$\pm(0.2\% + 80_{\mu}\text{V/s}) - \frac{10^{-5} \times \text{START Voltage (V)}}{\text{HOLD TIME (s)} + 2\text{s}}$$

- - if absolute setting value for START or STOP Voltage > 10V.

Linearity:

$$\pm\{0.1\% + \frac{0.0003\text{V/s}}{\text{RAMP RATE (V/s)}}\} - \frac{0.001 \times \text{START Voltage (V)}}{\text{RAMP RATE (V/s)} \times (\text{HOLD TIME (s)} + 2\text{s})} \%$$

$$\pm\{0.2\% + \frac{0.003\text{V/s}}{\text{RAMP RATE (V/s)}}\} - \frac{0.001 \times \text{START Voltage (V)}}{\text{RAMP RATE (V/s)} \times (\text{HOLD TIME (s)} + 2\text{s})} \%$$

- - if absolute setting value for START or STOP voltage > 10V.

- * : 1. Temperature Change: ≤ 3.6°C/hour.
 2. Time after start of ramp ≥ 2s.

Table 1-1. Specifications(sheet 4 of 7).

Start Stop Voltage (only for \nearrow , \searrow): $\pm 20\text{mV}$
 ($\pm 200\text{mV} \dots \geq 10\text{V}$ of absolute setting value for START or STOP voltage).

Display of Output Voltage (only for \nearrow , \searrow): $\pm(0.07\% + 16\text{mV})$
 ($\pm 0.09\% + 160\text{mV}$) $\geq 10\text{V}$ of absolute setting value for START or STOP
 voltage).

Step Delay/Hold Time: Accuracy is dependent on accuracy of line frequency
 (50Hz or 60Hz).

Current Limit: 10^{-4}A , 10^{-3}A or $10^{-2}\text{A} \pm 10\%$.

Output Terminals: BNC, L-GND.

C-V MEASUREMENT

Calculation Equation $C(\text{F}) = \text{measured current value (A)}/\text{ramp rate (V/s)}$

Measurement Range: $0.0\text{pF} \sim 189.9\text{pF}$, $190\text{pF} \sim 1900\text{pF}$, 2 ranges of Auto range,
 90% overrange.

% change Display: Capacitance change is displayed as a % of the initial setting
 value of C_{ox} (100%).

% Display Range: $0.0\% \sim 199.9\%$.

C_{ox} Setting Range: $0.1\text{pF} \sim 189.9\text{pF}$, $190\text{pF} \sim 1900\text{pF}$.

Capacitance Calculation Accuracy: Depends on accuracies of both current meas-
 urement and linearity of ramp wave
 (refer to paragraph 3-53).

Zero Offset: Cancels stray capacitances of test leads/fixtures.

Offset range: $0 \sim \pm 100\text{pF}$.

Table 1-1. Specifications(sheet 5 of 7).

OPTIONS

Option 001: Analog Output

Output Data: V_A , I and C

Output Voltage:

| Output Data | Output Voltage (Resolution) |
|---|--|
| V_A $\pm 10V$ $\pm 10.1V \sim \pm 100V$ | $0 \sim \pm 1.000V$ (1mV/count) $\pm 1.01 \sim \pm 10.00V$ (10mV/count) |
| I Full Scale | $\pm 5V$ (5mV/count) |
| C Full Scale 100pF 1000pF 100% (% Display) | 0.5V (0.5mV/count) 5V (5mV/count) 5V (5mV/count) |

Accuracy: $\pm(0.5\% + 20mV)$

Low Pass Filter: OFF, 0.22s $\pm 20\%$ and 1s $\pm 20\%$ applied to both V_A and I/C Data Output

Pen Lift Output: TTL low level ($\leq 0.8V$) during sweep period in I-V/C-V function

Recorder Scale Output: Upper right/lower left scale output for location adjustment of recorder

| Key | V_A output | I/C output |
|-----------------------|--|--|
| U.R. (Upper Right) | Either maximum voltage value of START or STOP voltages | Full scale value of (+) plus sign |
| L.L. (Lower Left) | Either minimum voltage value of START or STOP voltages | Full scale value of (-) minus sign. 0V (0pF) for C-V measurement |
| ZERO | 0V | 0V |

Option 101: HP-IB Interface (IEEE 488-1975, ANSI. STANDARD MC 1.1)

Interface Functions: SHI AHI T5 L4 SRI RL1 DC1 DT1

Remotely Controllable Functions: Measurement Function, Current Range, Integration Time, I Data Output Trigger, Voltage Sweep Control, Current Limit, Voltage of V_A/V_B , Setting Times and Self Test.

Data Output: Measured Data (I, C and V_A),
Voltage Settings (V_A , V_B),
Setting Times,
Setting Value of C_{ox} and,
Front Panel Key Status.

Table 1-1. Specifications(sheet 6 of 7).

- Option 907: Front Handle Kit (5061-0090).
 Option 908: Rack Flange Kit (5061-0078).
 Option 909: Rack and Handle Kit (5061-0084).
 Option 910: Extra Manual.

ACCESSORIES AVAILABLE

16053A: Test Leads (furnished with the 4140A)

One triaxial (male) - triaxial (male) cable, two BNC (male) - BNC (male) cables, and connection plate with female connectors (one triaxial and two BNC) are furnished. Each cable is 1 meter long. Useful for connecting prober station/measurement fixture designed by user.

16054A: Connection Selectors

Selects connection of low lead for pA Meter section as in following figure. Used in conjunction with the 16053A.

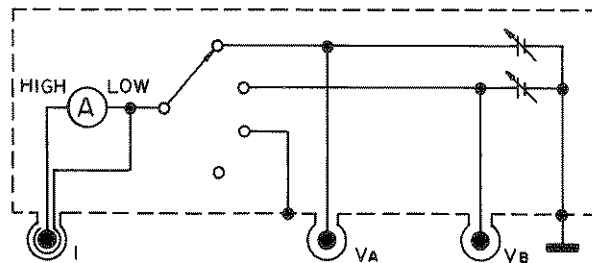

16055A: Test Fixture for General Device Measurements

For stable pA current measurements with electrostatic/light shielded hood. Alligator clips/T0-5 socket with connection plates for easy connection to actual devices.

16056A: Current Divider (10:1)

Extends 10^{-2} A range to 10^{-1} A (use only on 10^{-2} A range).

Table 1-1. Specifications(sheet 7 of 7).

Other Accessories/Recommended Stock Parts:

| Descriptions | HP Model/Part Number |
|--|---|
| HP-IB Cable 0.5m 1m 2m 4m | 10631D 10631A 10631B 10631C |
| Triaxial Connector Female Male { | 1250-0687 1250-1413 16053-24001 16053-24002 |
| BNC Connector Female Male | 1250-1279 1250-0408 |
| 16055A Accessories Connection Plate with Alligator Clip Connection Plate with T0-5 Socket (10pins) Alligator Clips (5ea) Connection Leads for T0-5 Socket (5ea) T0-5 Socket (8pins) T0-5 Socket (10pins) T0-5 Socket (12pins) | 16055-65001 16055-65002 16055-65003 16055-65004 1200-0238 1200-0239 1200-0240 |
| Triaxial Cable (approx 1m) | 16053-61002 |
| BNC-BNC Cable (approx 1m) | 16053-61003 |
| Connection Plate for the 16053A | 16053-61001 |

Table 1-2. General Information (sheet 1 of 2).

CURRENT MEASUREMENT

Typical Response time: 0 ~ 90%

| Measurement Range (A) | Response Time (s) | | Measurement Range (A) | Response Time (s) | |
|-------------------------------------|-------------------|---------|-----------------------|-------------------|---------|
| | C = 2pF | C = 2nF | | C = 2pF | C = 2nF |
| 10 ⁻² ~ 10 ⁻⁵ | ≤ 1ms | ≤ 1.5ms | 10 ⁻⁹ | ≤ 15ms | ≤ 40ms |
| 10 ⁻⁶ | ≤ 5ms | ≤ 5ms | 10 ⁻¹⁰ | ≤ 60ms | ≤ 1s |
| 10 ⁻⁷ | ≤ 3ms | ≤ 3ms | 10 ⁻¹¹ | ≤ 60ms | ≤ 1.5s |
| 10 ⁻⁸ | ≤ 20ms | ≤ 20ms | 10 ⁻¹² | ≤ 600ms | ≤ 2s |

"C" = capacitance value of test leads/fixtures

Common Mode Rejection Ratio: ≥120dB (≤ 2 counts)

Current Measurement Accuracy*:





| I RANGE (A) | INTEGRATION TIME | | High Speed I Data Out (Option 101 Only) |
|-------------------------------------|------------------|------------|---|
| | SHORT | MEDIUM | |
| 10 ⁻² ~ 10 ⁻⁹ | ±(0.5 + 4) | ±(0.5 + 3) | ±(0.5 + 6) |
| 10 ⁻¹⁰ | ±(2 + 4) | ±(2 + 3) | ±(2 + 6) |
| 10 ⁻¹¹ | ±(5 + 8) | ±(5 + 4) | ±(5 + 20) |
| 10 ⁻¹² ** | ±(5 + 13) | ±(5 + 10) | ±(5 + 25) |

* ±(% of reading + counts) at 23°C±5°C, ≤70% humidity.
** Zero offset is performed

Current Ranging Time:

10⁻² A ~ 10⁻⁷ A Ranges: 30ms
 10⁻⁸ A, 10⁻⁹ A Ranges: 200ms
 10⁻¹⁰ A ~ 10⁻¹² A Ranges: 1s

Data Output Trigger Cycle:

| VA | C-V | I-V |
|---|---|--------------|
|  ,  |  | 25ms ~ 103s* |
|  ,  | 50ms ~ 1000s** | |

* Step Delay Time + Integration time
 ** Step Voltage/Ramp Rate (dV/dt)

Table 1-2. General Information (sheet 2 of 2).

I Data Output Trigger:

| TRIGGER | I Function | High Speed I Data Output |
|---------|---------------|--------------------------|
| INT. | approx. 200ms | approx. 10ms* |
| EXT.** | ≥ 12ms | ≥ 2.5ms |
| MAN.*** | | ————— |

- * At 50Hz line frequency (x5/6 at 60Hz operation).
- ** Triggered when the logic signal ($\geq 1\mu\text{s}$) goes to "0" (short or $\leq 100\Omega$ of resistance) from "1".
- *** Triggered by HOLD/MAN. key.

DC VOLTAGE SOURCE

Output Resistance: $\leq 1\Omega$.

Output Impedance: $\leq 1\Omega$ at 10Hz, $\leq 100\Omega$ at 100Hz.

Program Speed (⏏, ⏏, ==): Approx. 2.5ms(1V/ms through rate)

Ranging: approx. 30ms.

1-19. OPTIONS.

1-20. Available Options for the Model 4140A are listed in Table 1-3.

Table 1-3. Available Options.

| Option | Description |
|--------|----------------------------------|
| 001 | Analog Output |
| 101 | HP-IB Interface |
| 907 | Front Handle Kit |
| 908 | Rack Flange Kit |
| 909 | Rack Flange and Front Handle Kit |
| 910 | Extra Manual |

1-21. Option 001 Analog Output.

1-22. The Option 001 Analog Output can be used to output analog I, C, and V_A data and to trace I-V/C-V curves by connecting an X-Y Recorder. The 4140A Option 001 can also control the pen of the X-Y recorder (up and down positions, etc.).

1-23. Option 101 HP-IB Interface.

1-24. The 4140A Option 101 HP-IB interface provides interfacing functions for transferring measured data to an HP-IB (Hewlett-Packard Interface Bus) line and to receive remote control signals from the HP Interface Bus line.

1-25. Option 907, 908 or 909.

1-26. Option 907, 908 or 909 provides the mechanical parts necessary for rack mounting. Installation procedures for these options are detailed in Section II.

1-27. Option 910 Extra Manual.

1-28. Option 910 Extra Manual provides an extra copy of Operating and Service Manual.

1-29. ACCESSORIES SUPPLIED.

1-30. Figure 1-1 shows the HP Model 4140A pA Meter/DC Voltage Source, Model 16053A Test Lead and power cord (HP Part No. 8120-1378). The 16053A and the power cord are furnished accessories.

1-31. ACCESSORIES AVAILABLE.

1-32. For convenience and ease of measurement, four styles of accessories are available. Photos and descriptions of accessories are given in Table 1-4 and application ranges of accessories are given in Table 1-5.

WARNING

DO NOT USE 16055A TEST FIXTURE WITH 16054A CONNECTION SELECTOR. HAZARDOUS VOLTAGE MAY EXIST ON LOW LEAD TERMINAL EVEN IF 16055A LOW LEAD CONNECTION SELECT SWITCH IS SET TO GND POSITION WHEN 16054A LOW LEAD CONNECTION SELECT SWITCH IS SET TO V_A OR V_B POSITION.

Table 1-5. Application Ranges of Accessories.

| Model | Current Range | In Combination |
|--------|--|----------------|
| 16053A | All ranges: $10^{-12}A \sim 10^{-2}A$ | |
| 16054A | | |
| 16055A | | |
| 16056A | $10^{-2}A$ range | |

Table 1-4. Accessories Available (Sheet 1 of 2).

| Model | Description |
|---|--|
|  | <p>16053A Test Lead (Furnished with the 4140A) Tri-axial Cable (1), BNC Cable (2), and Connection Plate.</p> <p>Triaxial Cable (HP P/N 16053-61002): Triaxial cable with triaxial male connectors. 1m length.</p> <p>BNC cable (HP P/N 16053-61003): Coaxial cable with BNC male connectors. 1m length.</p> <p>Connection Plate (HP P/N 16053-61001): Connection Plate with triaxial (1) and BNC (2) female connectors.</p> <p>Useful for connecting prober station, measurement fixture designed by user and other 4140A accessories.</p> |
|  | <p>16054A Connection Selector Selects connection of low lead for 4140A pA Meter section. Used in conjunction with the 16053A. Internal connections are approximately as follows:</p>  |

Table 1-4. Accessories Available (Sheet 2 of 2).

| Model | Description | | | | | | | | | | | | | | | | |
|---|--|--------------|--------|--------------------------------------|-------------|-----------------------|-------------|-----------------------------------|-------------|--|-------------|-----------------------|-----------|-----------------------|-----------|-----------------------|-----------|
|  | <p>16055A Test Fixture Used for general device measurements. For stable pA current measurements with electrostatic/light shielded hood. Furnished accessories, used in conjunction with the 16053A, include the following:</p> <table border="1" data-bbox="769 688 1463 1073"> <thead> <tr> <th data-bbox="769 688 1265 743">Descriptions</th> <th data-bbox="1265 688 1463 743">HP P/N</th> </tr> </thead> <tbody> <tr> <td data-bbox="769 743 1265 814">Connection plate with alligator clip</td> <td data-bbox="1265 743 1463 814">16055-65001</td> </tr> <tr> <td data-bbox="769 814 1265 846">Alligator clips (5ea)</td> <td data-bbox="1265 814 1463 846">16055-65003</td> </tr> <tr> <td data-bbox="769 846 1265 905">Connection plate with T0-5 socket</td> <td data-bbox="1265 846 1463 905">16055-65002</td> </tr> <tr> <td data-bbox="769 905 1265 963">Connection leads for T0-5 socket (5ea)</td> <td data-bbox="1265 905 1463 963">16055-65004</td> </tr> <tr> <td data-bbox="769 963 1265 995">T0-5 Socket (8 pins)</td> <td data-bbox="1265 963 1463 995">1200-0238</td> </tr> <tr> <td data-bbox="769 995 1265 1026">T0-5 Socket (10 pins)</td> <td data-bbox="1265 995 1463 1026">1200-0239</td> </tr> <tr> <td data-bbox="769 1026 1265 1058">T0-5 Socket (12 pins)</td> <td data-bbox="1265 1026 1463 1058">1200-0240</td> </tr> </tbody> </table> | Descriptions | HP P/N | Connection plate with alligator clip | 16055-65001 | Alligator clips (5ea) | 16055-65003 | Connection plate with T0-5 socket | 16055-65002 | Connection leads for T0-5 socket (5ea) | 16055-65004 | T0-5 Socket (8 pins) | 1200-0238 | T0-5 Socket (10 pins) | 1200-0239 | T0-5 Socket (12 pins) | 1200-0240 |
| Descriptions | HP P/N | | | | | | | | | | | | | | | | |
| Connection plate with alligator clip | 16055-65001 | | | | | | | | | | | | | | | | |
| Alligator clips (5ea) | 16055-65003 | | | | | | | | | | | | | | | | |
| Connection plate with T0-5 socket | 16055-65002 | | | | | | | | | | | | | | | | |
| Connection leads for T0-5 socket (5ea) | 16055-65004 | | | | | | | | | | | | | | | | |
| T0-5 Socket (8 pins) | 1200-0238 | | | | | | | | | | | | | | | | |
| T0-5 Socket (10 pins) | 1200-0239 | | | | | | | | | | | | | | | | |
| T0-5 Socket (12 pins) | 1200-0240 | | | | | | | | | | | | | | | | |
|  | <p>16056A Current Divider Extends 10^{-2}A range to 10^{-1}A. Useable only on 10^{-2}A range.</p> | | | | | | | | | | | | | | | | |

SECTION II INSTALLATION

2-1. INTRODUCTION

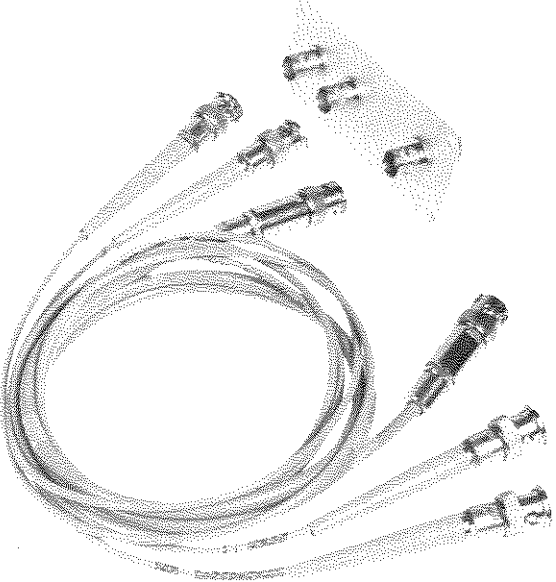
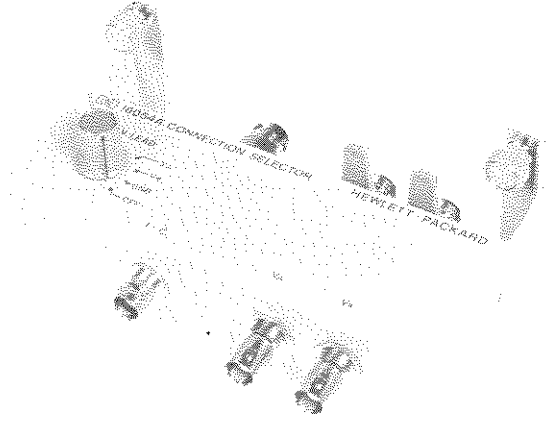
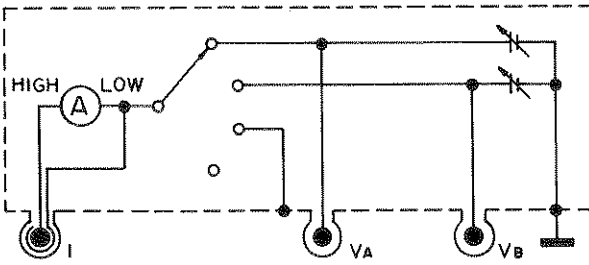
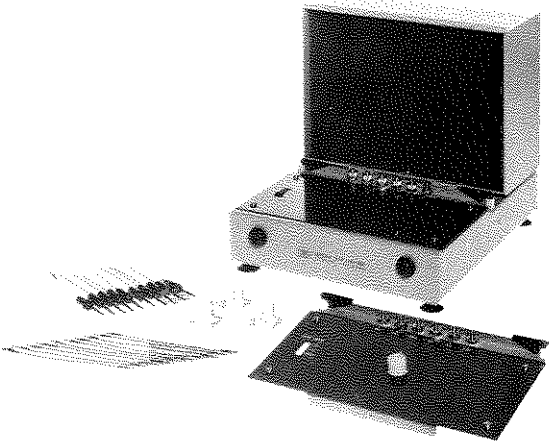
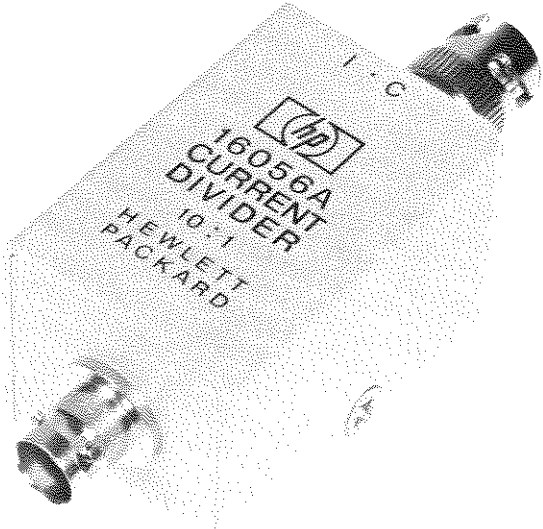
2-2. This section provides installation instructions for the Model 4140A pA Meter/DC Voltage Source and its accessories. This section also includes information for initial inspection and damage claims, preparations for using the 4140A and packaging, storage and shipment.

2-3. INITIAL INSPECTION

2-4. Inspect the shipping container for damage. If the shipping container or cushioning material is damaged, it should be kept until the contents of the shipment have been checked for completeness and the instrument has been checked mechanically and electrically. The contents of the shipment should be as shown in Figure 1-1; procedures for checking electrical performance are given in Section IV. If the contents are incomplete, if there is mechanical damage or defects, or if the 4140A does not pass the Performance Tests, notify the nearest Hewlett-Packard office. If the shipping container is damaged, or the cushioning material shows signs of stress, notify the carrier as well as your Hewlett-Packard office. Keep the shipping

materials for carrier's inspection. The HP office will arrange for repair or replacement at HP option without waiting for claim settlement.

WARNING

TO AVOID HAZARDOUS ELECTRICAL SHOCK, DO NOT PERFORM ELECTRICAL TESTS WHEN THERE ARE SIGNS OF SHIPPING DAMAGE TO ANY PORTION OF THE OUTER ENCLOSURE (COVERS, PANELS, OR METERS).

2-5. PREPARATION FOR USE

2-6. Power Requirements.

2-7. The 4140A requires a power source of 100, 120, 220Vac $\pm 10\%$, or 240Vac $+5\% -10\%$, 50, 60Hz $\pm 5\%$ single phase. Power consumption is less than 135VA.

2-8. Line Voltage Selection.

2-9. Figure 2-1 provides instructions for line voltage and fuse selection. The line voltage selection switch and the proper fuse are factory installed for 100 or 120Vac operation.

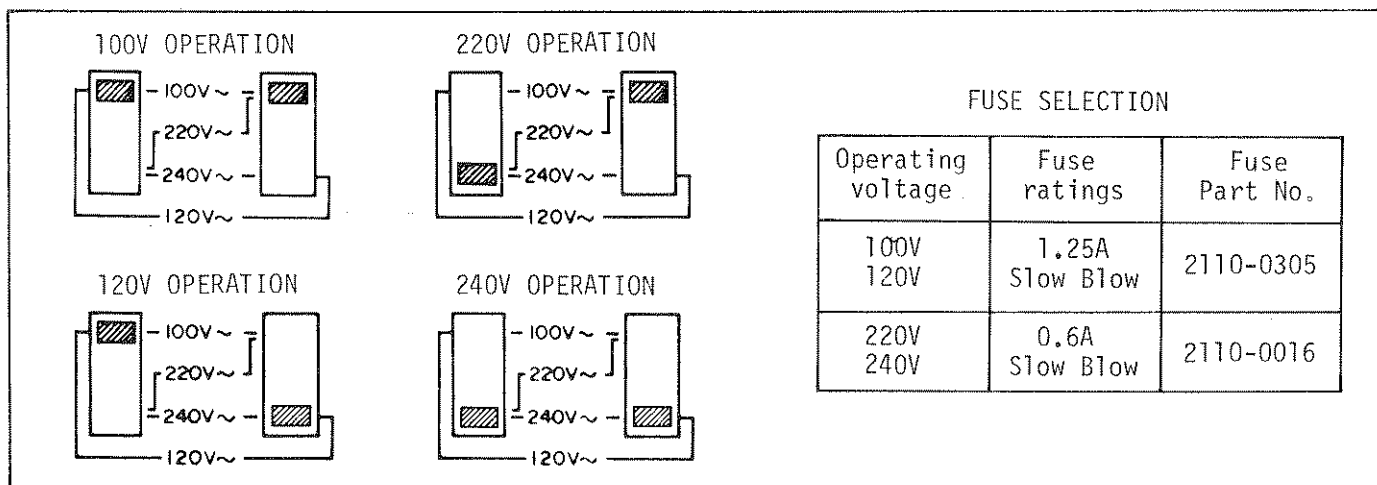

Figure 2-1. Line Voltage and Fuse Selection.

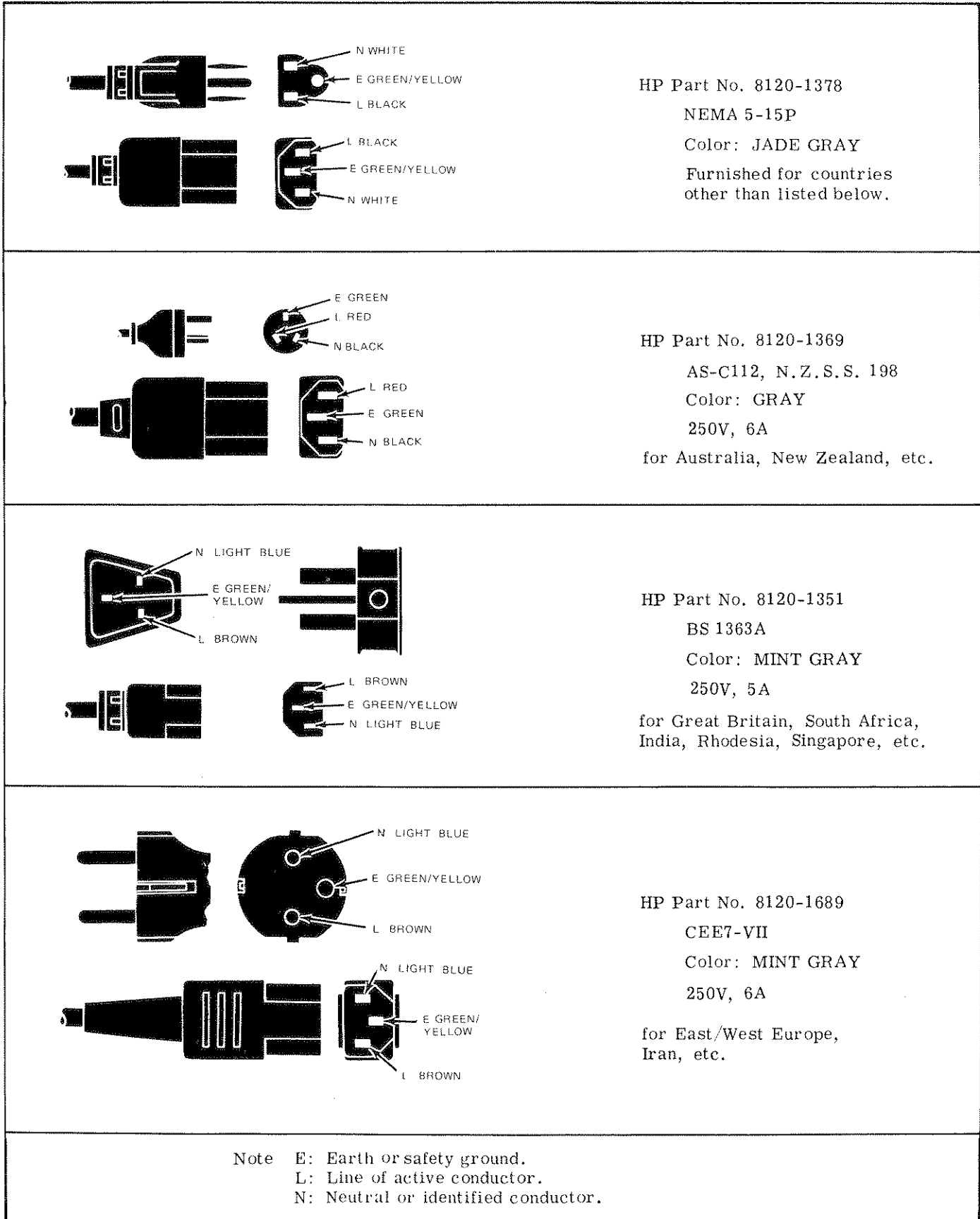

Figure 2-2. Power Cables Supplied.

2-10. Power Cable.

2-11. This instrument is equipped with a three-wire power cable. When connected to an appropriate ac power receptacle, this cable grounds the instrument cabinet. The type of power cable plug shipped with each instrument depends on the country of destination. Refer to Figure 2-2 for power cable part numbers and plug configurations available.

Note

Check local electrical codes for proper plug (attachment cap) selection for your area.

2-12. Operating Environment.

2-13. Temperature. The instrument may be operated in temperatures from 0°C to ±40°C.

2-14. Humidity. The instrument may be operated in environments with humidities up to 70% at 40°C. However, the instrument should be protected from temperature extremes which cause condensation within the instrument.

2-15. Installation Instructions.

2-16. The HP Model 4140A can be operated on the bench or in a rack mount. The 4140A is ready for bench operation as shipped from the factory. For bench operation, a two-leg instrument stand is used. For use, the instrument stands are designed to be pulled towards the front of instrument.

2-17. Installation of Options 907, 908 and 909.

2-18. The 4140A can be installed in a rack and be operated as a component of a measurement system. Rack mounting information for the 4140A is presented in Figure 2-3.

| Option | Kit Part Number | Parts Included | Part Number | Q'ty | Remarks |
|--------|--|--|-------------------------------------|-------------|----------|
| 907 | Handle Kit 5061-0090 | Front Handle Trim Strip #8-32 x 3/8 Screw | 5060-9900 5060-8897 2510-0195 | 2 2 8 | 9.525mm |
| 908 | Rack Flange Kit 5061-0078 | Rack Mount Flange #8-32 x 3/8 Screw | 5020-8863 2510-0193 | 2 8 | 9.525mm |
| 909 | Rack Flange & Handle Kit 5061-0084 | Front Handle Rack Mount Flange #8-32 x 3/8 Screw | 5060-9900 5020-8875 2510-0194 | 2 2 8 | 15.875mm |

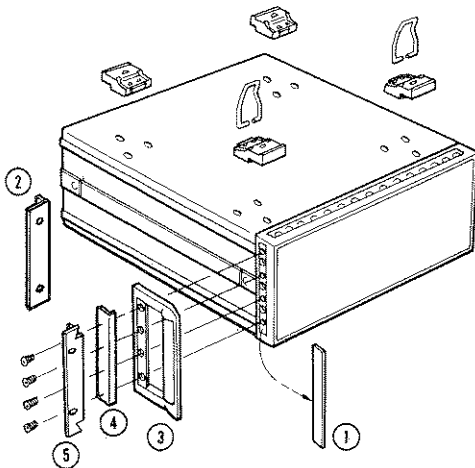

1. Remove adhesive-backed trim strips (1) from sides at right and left front of instrument.
2. HANDLE INSTALLATION: Attach front handle (3) to sides at right and left front of instrument with screws provided and attach trim strip (4) to handle.
3. RACK MOUNTING: Attach rack mount flange (2) to sides at right and left front of instrument with screws provided.
4. HANDLE AND RACK MOUNTING: Attach front handle (3) and rack mount flange (5) together to sides at right and left front of instrument with screws provided.
5. When rack mounting (3 and 4 above), remove all four feet (lift bar at inner side of foot, and slide foot toward the bar).

Figure 2-3. Rack Mount Kit.

2-19. STORAGE AND SHIPMENT

2-20. Environment.

2-21. The instrument may be stored or shipped in environments within the following limits:

- Temperature -40°C to +75°C
- Humidity Up to 95% at +45°C

The instrument should also be protected from temperature extremes which could cause condensation within the instrument.

2-22. Packaging.

2-23. Original Packaging. Containers and materials identical to those used in factory packaging are available through Hewlett-Packard offices. If the instrument is being returned to Hewlett-Packard for servicing, attach a tag including the type of service required, return address, model number, and full serial number. Also, mark the container FRAGILE to ensure careful handling. In any correspondence, refer to the instrument by model number and full serial number.

2-24. Other Packaging. The following general instructions should be used for re-packing with commercially available materials:

- a. Wrap instrument in heavy paper or plastic. (If shipping to Hewlett-Packard office or service center, attach tag

indicating type of service required, return address, model number and full serial number.)

- b. Use strong shipping container. A double-wall carton made of 350-pound test material is adequate.
- c. Use a layer of shock-absorbing material 70 to 100mm (3 to 4 inches) thick around all sides of the instrument to provide firm cushioning and to prevent movement inside container. Protect control panel with cardboard.
- d. Seal shipping container securely.
- e. Mark shipping container FRAGILE to ensure careful handling.
- f. In any correspondence, refer to instrument by model number and full serial number.

2-25. OPTION INSTALLATION

2-26. Installation procedures for Options 001 and 101 are described in Table 2-1.

CAUTION

BEFORE PROCEEDING WITH INSTALLATION OF OPTION(S), PUSH LINE BUTTON TO OFF AND REMOVE POWER CORD FROM INSTRUMENT.

Table 2-1. Option Installation.

| | Option 001 Analog Output | Option 101 HP-IB Interface |
|------------------------|--|--|
| Option Parts | Analog Output Assembly (HP P/N: 04140-61001) | A21 HP-IB Board Assembly (HP P/N: 04140-66521) |
| Installation Procedure | <ol style="list-style-type: none"> 1. Remove left rectangular blind from rear panel. 2. Install Analog Output assembly on rear edge connector of A4 I/O board. 3. Fasten Analog Output assembly to rear panel with four screws. | <ol style="list-style-type: none"> 1. Remove right rectangular blind from rear panel. 2. Install A21 HP-IB board assembly on rear edge connector of A3 MPU board. 3. Fasten A21 HP-IB board assembly to rear panel with two screws. |

SECTION III

OPERATION

3-1. INTRODUCTION.

3-2. This section provides the operating instructions for acquainting the user with the Model 4140A pA Meter/DC Voltage Source. Instructions for panel controls, measurement functions, operating procedures, self test, and option information are included in this section. Operating precautions given throughout the text should be carefully observed.

WARNING

BEFORE THE INSTRUMENT IS SWITCHED ON, ALL PROTECTIVE EARTH TERMINALS, EXTENSION CORDS, AUTO-TRANSFORMERS AND DEVICES CONNECTED TO IT SHOULD BE CONNECTED TO A PROTECTIVE EARTH GROUNDED SOCKET. ANY INTERRUPTION OF THE PROTECTIVE EARTH GROUNDING WILL CAUSE A POTENTIAL SHOCK HAZARD THAT COULD RESULT IN PERSONAL INJURY. ONLY FUSES OF THE SPECIFIED TYPE AND OF THE REQUIRED RATED CURRENT SHOULD BE USED. DO NOT USE REPAIRED FUSES OR SHORT CIRCUITED FUSEHOLDERS. TO DO SO COULD CAUSE A SHOCK OR FIRE HAZARD.

CAUTION

BEFORE THE INSTRUMENT IS SWITCHED ON, IT MUST BE SET FOR THE VOLTAGE OF THE POWER SOURCE OR DAMAGE TO THE INSTRUMENT MAY RESULT.

3-3. PANEL FEATURES.

3-4. Front and rear panel features are described in Figures 3-1 and 3-2. Description numbers match the numbers on the illustration. Other detailed information for panel displays and controls is covered in paragraph 3-5 and those which follow.

3-5. SELF TEST.

3-6. The 4140A has the following self test functions:

- (1) A Program Memory Test
- (2) A Display Test

These tests are automatically performed once each time the LINE button is pushed to turn instrument on. In addition, these tests are enabled when SELF TEST key is pushed. Under this latter condition, the tests are performed repeatedly while SELF TEST lamp is lit. In Option 101 units, these tests can be enabled by a remote program via the HP-IB.

- (1) Program Memory Test.

During the Self Test mode, the instrument is checking the internal program memory. If some abnormality is detected, instrument displays one of the eight error messages (E-2~E-9). Six of the error messages (E-2~E-7) indicate an abnormality in the ROM (Read Only Memory) and the other two error messages (E-8 or E-9) indicate an abnormality of the RAM (Random Access Memory). Suffix numbers are same as numbers for ROM or RAM.

- (2) Display Test.

During the Self Test mode, all front panel indicator lamps and all segments of numeric and character displays are illuminated.

3-7. When 4140A is set to Self Test mode by the SELF TEST key, the 4140A has an additional Self Test function (a Control Key Test). If each control key is normal, the I·C DISPLAY displays an octal code as shown in Figure 3-3, when a control key is pushed.

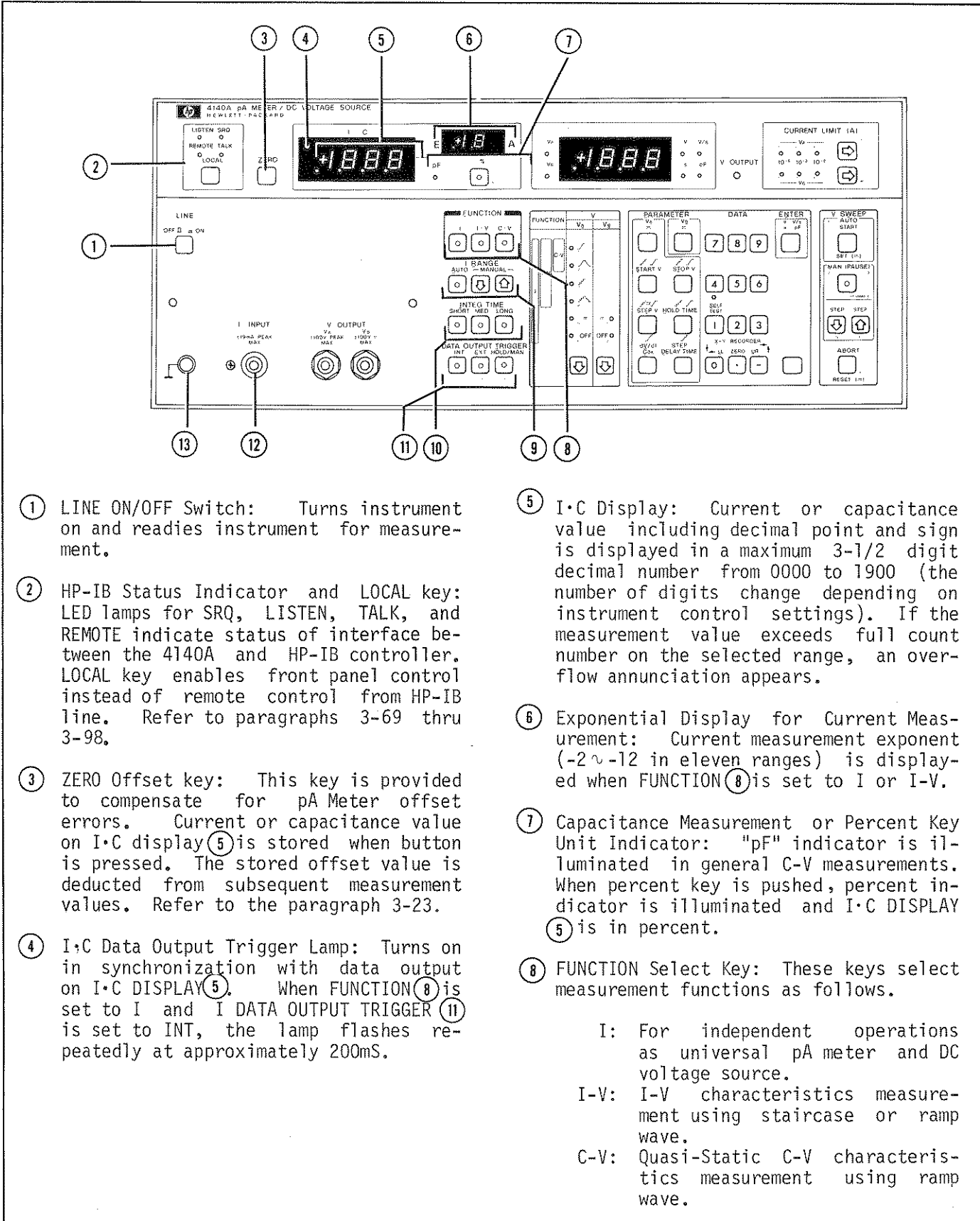

- ① LINE ON/OFF Switch: Turns instrument on and readies instrument for measurement.
- ② HP-IB Status Indicator and LOCAL key: LED lamps for SRQ, LISTEN, TALK, and REMOTE indicate status of interface between the 4140A and HP-IB controller. LOCAL key enables front panel control instead of remote control from HP-IB line. Refer to paragraphs 3-69 thru 3-98.
- ③ ZERO Offset key: This key is provided to compensate for pA Meter offset errors. Current or capacitance value on I·C display ⑤ is stored when button is pressed. The stored offset value is deducted from subsequent measurement values. Refer to the paragraph 3-23.
- ④ I·C Data Output Trigger Lamp: Turns on in synchronization with data output on I·C DISPLAY ⑤. When FUNCTION ⑧ is set to I and I DATA OUTPUT TRIGGER ⑪ is set to INT, the lamp flashes repeatedly at approximately 200mS.

- ⑤ I·C Display: Current or capacitance value including decimal point and sign is displayed in a maximum 3-1/2 digit decimal number from 0000 to 1900 (the number of digits change depending on instrument control settings). If the measurement value exceeds full count number on the selected range, an overflow annunciation appears.
- ⑥ Exponential Display for Current Measurement: Current measurement exponent (-2 ~ -12 in eleven ranges) is displayed when FUNCTION ⑧ is set to I or I-V.
- ⑦ Capacitance Measurement or Percent Key Unit Indicator: "pF" indicator is illuminated in general C-V measurements. When percent key is pushed, percent indicator is illuminated and I·C DISPLAY ⑤ is in percent.
- ⑧ FUNCTION Select Key: These keys select measurement functions as follows.
 - I: For independent operations as universal pA meter and DC voltage source.
 - I-V: I-V characteristics measurement using staircase or ramp wave.
 - C-V: Quasi-Static C-V characteristics measurement using ramp wave.

Figure 3-1. Front Panel Features (sheet 1 of 5).

⑨ I RANGE Select Key: These keys select the current measurement ranging method. In AUTO mode (when LED lamp is lit), optimum range for the current value is automatically selected. In MANUAL mode (when LED lamp is not lit), measurement range remains the same even when the current value is changed. Manual ranging is done by pressing adjacent DOWN (⏴) or UP (⏵) key. Refer to paragraph 3-16.

Note

Pressing DOWN (⏴) or UP (⏵) key sets the ranging mode to Manual even if the ranging mode was set to AUTO.

⑩ INTEGRATION TIME Select Key: These keys select digital integration time in accord with the following table for the various measuring conditions:

| Range(A) | Integration Time (ms)* | | |
|-------------------------|------------------------|------------|--------------|
| | Short | Medium | Long |
| $10^{-2} \sim 10^{-10}$ | 20(16.7) | 80(66.7) | 320(266.7) |
| 10^{-11} | 80(66.7) | 320(266.7) | 1280(1066.7) |
| 10^{-12} | 160(133.3) | 640(533.3) | 2569(2133.3) |

*Note: at 50 (60)Hz line frequency.

⑪ I DATA OUTPUT TRIGGER Select key: These keys select trigger mode for triggering I Data Output when FUNCTION is set to I as follows:

INT: This key provides internal trigger which enables instrument to output current data measurement repeated at 200mS (approximate) rate.

EXT: In external trigger mode, a trigger signal must be applied to EXT TRIGGER input connector or rear panel to trigger instrument.

HOLD/MANUAL: In HOLD/MANUAL trigger mode, a trigger signal is provided when this key is pressed.

Note

A 4140A equipped with Option 101 HP-IB Interface can be triggered by a trigger command (GET), regardless of mode setting of I DATA OUTPUT TRIGGER key.

⑫ I INPUT Connector: This connector is a triaxial female connector for connecting unknown current source, test lead, or test fixture.

⑬ GROUND Terminal: This terminal is connected to chassis ground of instrument and can be used as ground terminal in measurements which specifically require use of a guard.

Figure 3-1. Front Panel Features (sheet 2 of 5).

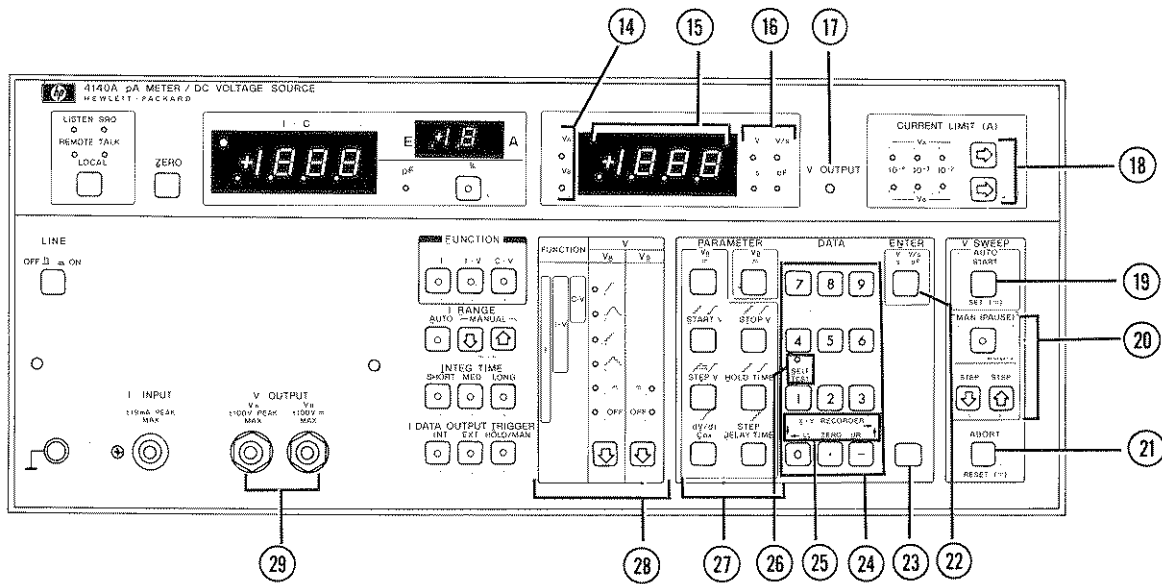

⑭ VA, VB Lamps: These lamps indicate voltage value of the VS DISPLAY ⑮ is VA or VB. Usually, VA lamp is illuminated. When VA is set to OFF and VB is set to ON (VS Mode key ⑳), VB lamp is illuminated.

⑮ VS (Voltage Source) Display: Output voltage value, including decimal point and sign, is displayed in a maximum 3-1/2 digit decimal number from 0000 to 1900 (the number of digits change depending on instrument control settings). Usually, output voltage VA value is displayed. When VA is set to OFF and VB is set to ON (VS Mode Key ⑳), output voltage VB value is displayed. In addition, when V OUTPUT lamp is not lit, this display can be used to display parameter values. If the input parameter value exceeds its limit value, and overflow annunciation appears. If the 4140A is swept at incorrect parameter settings, an illegal annunciator appears.

⑯ Unit Indicator lamps: These lamps indicate unit of VS DISPLAY ⑮ as follows:

- V: Output Voltage, = (VA or VB), START V, STOP V, STEP V.
- s: HOLD TIME, STEP DELAY TIME.
- V/s: dV/dt.
- pF: Cox.

⑰ V OUTPUT Lamp: When the DC Voltage Source is operating, this lamp is lit.

⑱ CURRENT LIMIT Lamps and Select Keys: These lamps indicate output current limit of VA or VB. If output current goes to limit value, this lamp flashes. Select keys select output current limit of VA or VB to 100μA, 1mA or 10mA.

⑲ V SWEEP AUTO START (SET =) key: This key is used to start auto sweep when VA is set to sweep mode and sets DC voltage of VB. When VA is set to DC (=) mode, this key is used to set DC voltages for VA or VB.

Figure 3-1. Front Panel Features (sheet 3 of 5).

- ⑳ V SWEEP MAN (PAUSE), STEP DOWN (Ⓜ) and STEP UP (Ⓨ) Keys: MAN (PAUSE) key is usually used to start manual sweep. When VA is operating in auto sweep mode, this key is used as the auto sweep pause control. The key can change the sweep from auto (when LED lamp is not lit) to manual mode (when LED lamp is lit) or from manual to auto. The STEP DOWN and STEP UP keys are used for manual sweep.
- ㉑ V SWEEP ABORT (RESET \equiv) Key: This key is used to abort all operations of the DC Voltage Source.
- ㉒ ENTER Key: When this key is pushed after the value of the parameter is set with the PARAMETER select (㉗) and DATA (㉔) keys, the set value is stored in the 4140A. The VS DISPLAY (15) indication flashes once when this key is pushed.
- ㉓ Blue Keys: Functions in blue letters (Cox, SELF TEST, X-Y RECORDER) are effective after this key is pushed.
- ㉔ DATA Keys: These keys are used to input parameter values. They are made up of numeric (0~9), decimal and minus keys.
- ㉕ X-Y RECORDER Control Keys: In an instrument equipped with Option 001, these keys are used to control pen position of the X-Y recorder connected to ANALOG OUTPUT connectors on rear panel and include:
- LL: Moves pen position to lower left of sweep area.
 - ZERO: Sets both outputs to 0V.
 - UR: Moves pen position to upper right of sweep area.
- These control keys are effective after Blue key is pushed.
- ㉖ SELF TEST key and lamp: This key is used to set 4140A to Self Test mode and lamp is lit during Self Test mode operation. This key is effective after the Blue key (㉓) is pushed. Refer to paragraph 3-5.
- ㉗ PARAMETER Select Keys: These keys are used to set and monitor measurement parameters for DC Voltage Source. When V OUTPUT Lamp (17) is lit, Parameters can not be set. Parameters can be monitored when these keys are pushed:
- VA Mode
 - \equiv : DC Voltage (V) of no sweep mode.
 - START V: Start voltage (V) of sweep mode.
 - STOP V: Stop voltage (V) of sweep mode.
 - STEP V: Step voltage (V) of sweep mode.
 - HOLD TIME: Hold time (s) of start and stop voltages of the sweep mode.
 - dV/dt: Rate of change of ramp wave voltage.
 - Cox: Reference capacitance value (C oxide) (pF) of a C-V measurement in percent. This key is effective after Blue key (㉓) is pushed.
 - STEP DELAY TIME: Delay time(s) of each step of staircase wave.
 - VB Mode
 - \equiv : DC Voltage (V).

Figure 3-1. Front Panel Features (sheet 4 of 5).

28 VS (Voltage Source) Mode Lamps and Select Keys: These lamps indicate VS mode settings as follows:

• VA Mode

↗ (Single Ramp Wave): Output voltage is changing continuously (dv/dt) from start voltage to stop voltage.

↘ (Double Ramp Wave): Output voltage is changing continuously (dv/dt) from start voltage to stop voltage. Successively, output voltage is returned to start voltage at same ramp rate.

⌚ (Single Staircase Wave): Output voltage is changed step-by-step in step voltage fashion from start to stop voltage.

⌚ (Double Staircase Wave): Output voltage is changed in step-by-step voltage fashion from start to stop voltage. Successively, output voltage is returned to start voltage by same step voltage.

== (DC): DC voltage is outputted.

OFF: VA is not operating.

• VB Mode

== (DC): DC voltage is outputted.

OFF: VB is not operating.

Select keys select VA and VB mode in accord with following table:

| FUNCTION | VA | | | | | | VB | |
|----------|----|---|---|---|----|-----|----|-----|
| | ↗ | ↘ | ⌚ | ⌚ | == | OFF | == | OFF |
| I | ○ | ○ | ⊙ | ○ | ○ | ○ | ○ | ⊙ |
| I-V | ○ | ○ | ⊙ | ○ | x | x | ○ | ○ |
| C-V | ⊙ | ○ | x | x | x | x | ○ | ○ |

x: This mode is not used.

⊙: Initial Settings.

29 V OUTPUT Connectors: These connectors are BNC female connectors to connect unknown samples, test leads or test fixtures.

Figure 3-1. Front Panel Features (sheet 5 of 5).

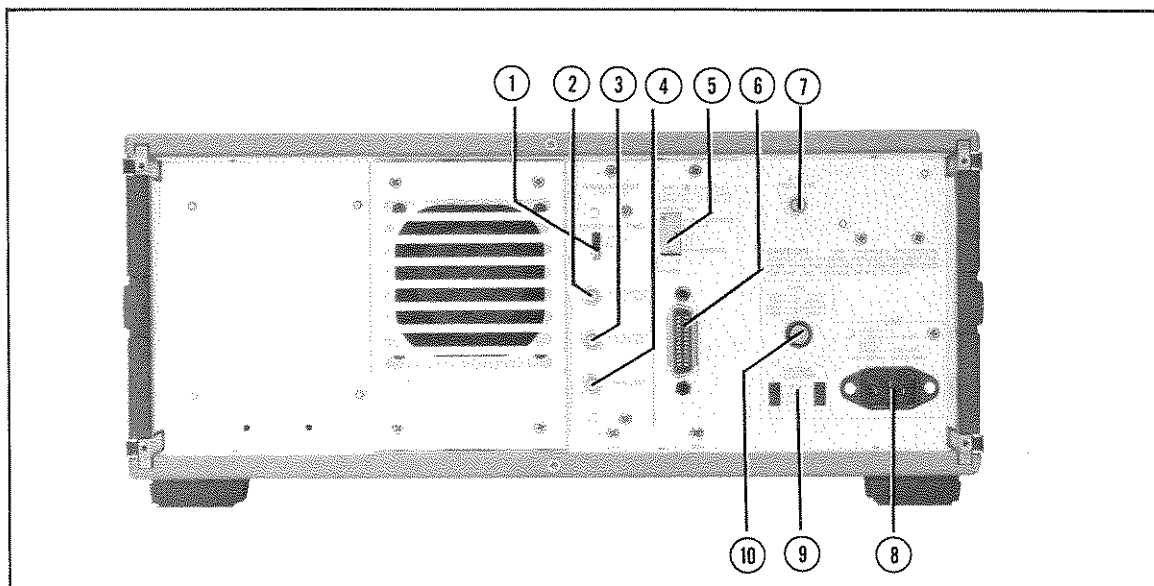

Figure 3-2. Rear Panel Features (sheet 1 of 2).

① FILTER TIME CONST Select Switch: In option 001 instruments, this switch selects filter rise time (OFF, 0.22s or 1s) for optimizing analog output.

② VA OUTPUT Connector: In Option 001 operation, analog output data of 4140A VA OUTPUT is outputted from this connector in accord with the following table:

| VA (V) | VA OUTPUT (V) | RESOLUTION |
|---------------|---------------|------------|
| 0.00 ~±10.00 | 0.000 ~±1.000 | 1mV/count |
| ±10.1 ~±100.0 | ±1.01 ~±10.00 | 10mV/count |

③ I/C OUTPUT Connector: In Option 001 instruments, analog output data of 4140A I·C DISPLAY is outputted from this connector in accord with the following table:

| I DISPLAY | I OUTPUT (V) | RESOLUTION |
|-----------|----------------|------------|
| 0 ~±1900 | 0.000 ~ ±9.500 | 5mV/count |

| C DISPLAY | C OUTPUT (V) | RESOLUTION |
|------------|----------------|-------------------|
| 0.0 ~190.0 | 0.0000 ~0.9500 | 500 μ V/count |
| 191 ~1900 | 0.955 ~9.500 | 5mV/count |

| % DISPLAY | % OUTPUT (V) | RESOLUTION |
|------------|--------------|------------|
| 0.0 ~199.9 | 0.000 ~9.995 | 5mV/count |

④ PEN LIFT Connector: In Option 001 units, PEN LIFT control signal for an X-Y recorder connected to the 4140A, is outputted from this connector. When VA OUTPUT and I/C OUTPUT connectors are outputting analog output data, this connector outputs a LOW level TTL signal (PEN DOWN). At other times, this connector outputs a HIGH level TTL signal (PEN UP).

⑤ HP-IB Control Switch: In Option 101 units, this switch selects HP-IB address, data output format, and interface capability. Refer to paragraph 3-77.

⑥ HP-IB Connector: In Option 101 units, an HP-IB cable can be connected for intercommunication with other HP-IB devices through the bus line cable.

⑦ EXT TRIGGER Connector: This connector is used for externally triggering pA Meter by inputting an external trigger signal when FUNCTION is set to I. TRIGGER switch on front panel should be set to EXT. Refer to paragraph 3-21.

⑧ LINE Input Receptacle: AC power cord is connected to this receptacle and to AC power line.

⑨ VOLTAGE SELECTOR switch: These switches select appropriate an operating power voltage from among 100, 120, 220V \pm 10% and 240V +5% -10%, 48 ~66Hz. Refer to paragraph 2-8.

⑩ FUSE Holder: Instrument power line fuse is installed in this holder. Refer to paragraph 2-8.

Figure 3-2. Rear Panel Features (sheet 2 of 2).

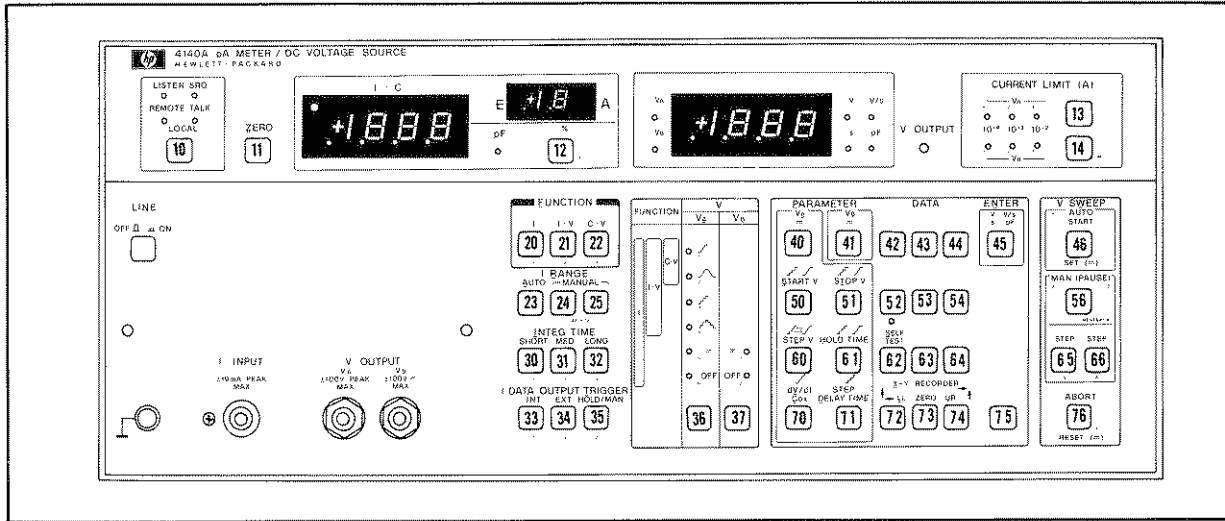

Figure 3-3. Octal Codes of Control Keys.

3-8. INITIAL CONTROL SETTINGS.

3-9. One of the convenient functions which facilitate ease of operation is the automatic initial control setting performed after the instrument is turned on. Initial panel control functions are automatically set as follows:

FUNCTION I
 I RANGE AUTO
 INTEG TIME LONG
 I DATA OUTPUT TRIGGER INT
 VA
 VB OFF
 PARAMETERS all parameters are 0
 SELF TEST OFF
 I ZERO OFFSET 0
 C ZERO OFFSET 0
 CURRENT LIMIT 100 pA

Additionally, when FUNCTION is changed, panel control functions are automatically set as in Table 3-1.

Table 3-1. Automatic Control Settings.

| CONTROLS | FUNCTION | | |
|-----------------------|----------|------|------|
| | I | I-V | C-V* |
| I RANGE | AUTO | AUTO | ** |
| I DATA OUTPUT TRIGGER | INT | OFF | OFF |
| VA | | | |

* C measurement Unit indicator is set to pA.

** I RANGE when FUNCTION is set to C-V, INTEG TIME, VB, PARAMETERS SELF TEST I ZERO OFFSET, C ZERO OFFSET, and CURRENT LIMIT are not changed when FUNCTION is changed.

3-10. MEASUREMENT FUNCTION.

3-11. The 4140A has three measurement functions which are:

- I: For independent operations as a universal pA Meter and DC Voltage Source.
- I-V: I-V characteristics measurement using Staircase and Ramp wave.
- C-V: Quasi-Static C-V characteristics measurement using Ramp wave.

In the following paragraphs of this section, basic information for the pA Meter and DC Voltage Source when FUNCTION is set to I is first described and secondly I-V and C-V measurements are outlined.

3-12. pA (PICO-AMPERE) METER SECTION.

3-13. The pA Meter section of the Model 4140A operates as an independent, high stability universal pA Meter (to 10^{-15} A max) when the FUNCTION is set to I. In addition, accurate I-V measurements, with staircase or ramp wave, the timing of either of which can be automatically synchronized between the pA Meter section and the DC Voltage Source section, can be done in the I-V function. In the C-V function, accurate I-V measurements using the ramp wave and calculating the capacitance from the current measurement value and ramp rate (dV/dt), can be done. Independent operation as a universal pA Meter is chiefly described in paragraphs 3-12 thru 3-26. These instructions should be read even if only I-V or C-V measurements are to be done. Instructions for I-V measurements are given in paragraphs 3-43 thru 3-48 and for C-V measurements in paragraphs 3-49 thru 3-60 should be read.

3-14. pA Meter Display.

3-15. The primary display, sub-display and two LED lamps provide visual data outputs of current measurement result or the result of capacitance calculations. The primary display (I·C DISPLAY) provides a readout of current measurement value, calculated capacitance value or the capacitance value as a percent of the reference value (Cox) in a maximum 4 digit decimal number with decimal point. If measurement overflows, an alphabetic annunciation (either O-F, COF or POF) is displayed (refer to paragraph 3-61). The sub-display provides the exponent of the current measurement (-2 to -12 in eleven ranges) when FUNCTION is set to I or I-V. Two LED lamps serve as the unit indicators for the capacitance measurement. These lamps indicate that the value of the I·C DISPLAY is the calculated capacitance (pF) or the capacitance value in percent referenced to a capacitance value (Cox). In a C-V measurement, lesser significant digit data of the calculated capacitance is displayed when the current measurement data has few significant digits. In an I·C DISPLAY, the lesser significant digit data is represented by a small zero (0) figure to differentiate it from a more significant digit which is represented by a large zero (0) as shown in Figure 3-3.

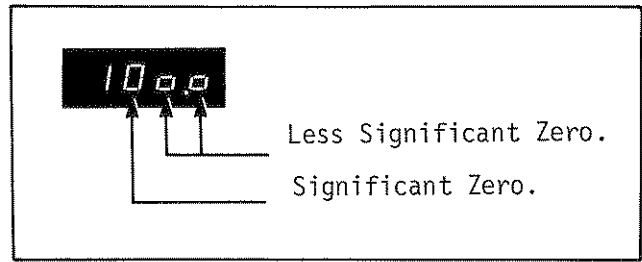

Figure 3-4. Less Significant Zero.

The display for the pA Meter displays the following parameter values in like manner (to those described above):

- Measuring Current $\pm 0.001 \times 10^{-12}$ A
 $\sim \pm 1.900 \times 10^{-2}$ A.
- Calculated Capacitance .. 0.0pF \sim 189.9pF,
 190pF \sim 1900pF.
- Capacitance in Percent .. 0.0% \sim 199.9%.

3-16. Current Measurement Ranges.

3-17. The pA Meter of the 4140A covers currents measurable by the instrument from 10^{-12} A to 10^{-2} A in 11 ranges. Each range allows a 90% overrange of the 1000 full scale count (maximum 1900 counts). The 4140A has two range modes, AUTO and MANUAL, for selecting the optimum range for making the various current measurements. When the I RANGE is set to AUTO, an optimum range is automatically selected for each measurement. If the raw current measurement data (before digital integration - - refer to paragraph 3-18 - -) is outside the range of 150 \sim 1900 counts, the measurement range is changed automatically - - up or down by the AUTO ranging system. When the I RANGE is set to MANUAL, the measurement range does not change even if measured current changes. If the DOWN (D) or UP (U) key is pushed, the measurement range is changed and the I RANGE is set to MANUAL (even if the I RANGE was set to AUTO). If the I·C DISPLAY count is over 1900 counts when measurement range is held, the I·C DISPLAY displays an (O-F) annunciation. When the measurement range is changed, the pA Meter waits for the following ranging times:

- $10^{-10} \sim 10^{-12}$ A ranges 1s
- $10^{-8} \sim 10^{-9}$ A ranges 200ms
- $10^{-2} \sim 10^{-7}$ A ranges 20 \sim 30ms

3-18. Integration Time and Data Output.

3-19. The raw current measurement of the 4140A pA Meter section is done by making successive approximations between the reference voltage (using a high speed D-A converter) and a voltage proportional to the measured current. This raw current measurement is synchronized with the line frequency. Thus, the raw current measurement interval of the 4140A is 10(8.3)ms at 50(60)Hz line frequency and this measurement continues from the time the 4140A is turned ON until it is turned OFF. These raw current measurement data are digitally integrated and this result is outputted to the I·C DISPLAY. The number of the raw current measurement data selected for digital integration (2~256) is fixed by the INTEG TIME select key on the front panel. The integration time of the 4140A pA Meter section is the product of the number of raw current measurement data selected for digital integration and the current measurement interval. The 4140A has nine integration times as given in Table 3-2 which are selected by measurement range and unknown condition.

Table 3-2. Current Measurement Integration Times.

| Range(A) | Integration Time (ms)* | | |
|-------------------------|------------------------|------------|--------------|
| | Short | Medium | Long |
| $10^{-2} \sim 10^{-10}$ | 20(16.7) | 80(66.7) | 320(266.7) |
| 10^{-11} | 80(66.7) | 320(266.7) | 1280(1066.7) |
| 10^{-12} | 160(133.3) | 640(533.3) | 2560(2133.3) |

*Note: at 50 (60)Hz line frequency.

3-20. When the FUNCTION is set to I, the digital integration is made using raw current measurement data already available when the I Output Data Trigger is received as shown in Figure 3-5. Therefore, I data output is completed as soon as the I Output Data Trigger is received. The I Data Output Trigger interval requires only 10(8.3)ms which is the raw current measurement interval and is not related to integration time. The relationship of the integration time to the data output when FUNCTION is set to I-V or C-V is described in paragraph 3-47 or 3-53.

Note

Immediately after 4140A is turned on and for about 2.56s (max.), inappropriate I data is outputted as

raw current measurement data since insufficient numbers have yet been accumulated for digital integration.

3-21. External Triggering.

3-22. The 4140A pA Meter section can be triggered by an external trigger signal for outputting current measurement data. To trigger the 4140A externally, set 4140A front panel controls as follows:

FUNCTION I
 I DATA OUTPUT TRIGGER EXT

The external triggering device should be connected to EXT TRIGGER connector (BNC female type) on rear panel. The 4140A can be triggered by a TTL level signal that changes from high (+5V) to low (0V). Trigger pulse with must be greater than 1μs. Triggering can also be done by alternately shorting (or with resistance 100Ω) and opening the center conductor of the EXT TRIGGER connector to ground (chassis).

Note

The center conductor of the EXT TRIGGER connector is normally at high level (no input).

Note

With Option 101 HP-IB Interface, triggering can be also done by trigger command (GET) or remote program code "E" via the HP-IB. Refer to Figure 3-28.

3-23. Zero Offset for Current Measurement.

3-24. The 4140A has a zero offset function which can be used to cancel the offset error of an undesired input current (e.g. leakage current of test leads/test fixtures) to reduce the measurement error to minimum. The method doing the zero offset is described in Figure 3-6. The current measurement offset limit is 0 ~ 100fA and the zero offset function can be used only on the 10^{-12} A range. If ZERO OFFSET key is pushed when measurement range is other than 10^{-12} A, this action is ignored. The zero offset value is set to 0fA when the 4140A is turned on. When the ZERO offset key is pushed, the value of the I·C DISPLAY adds to zero offset value.

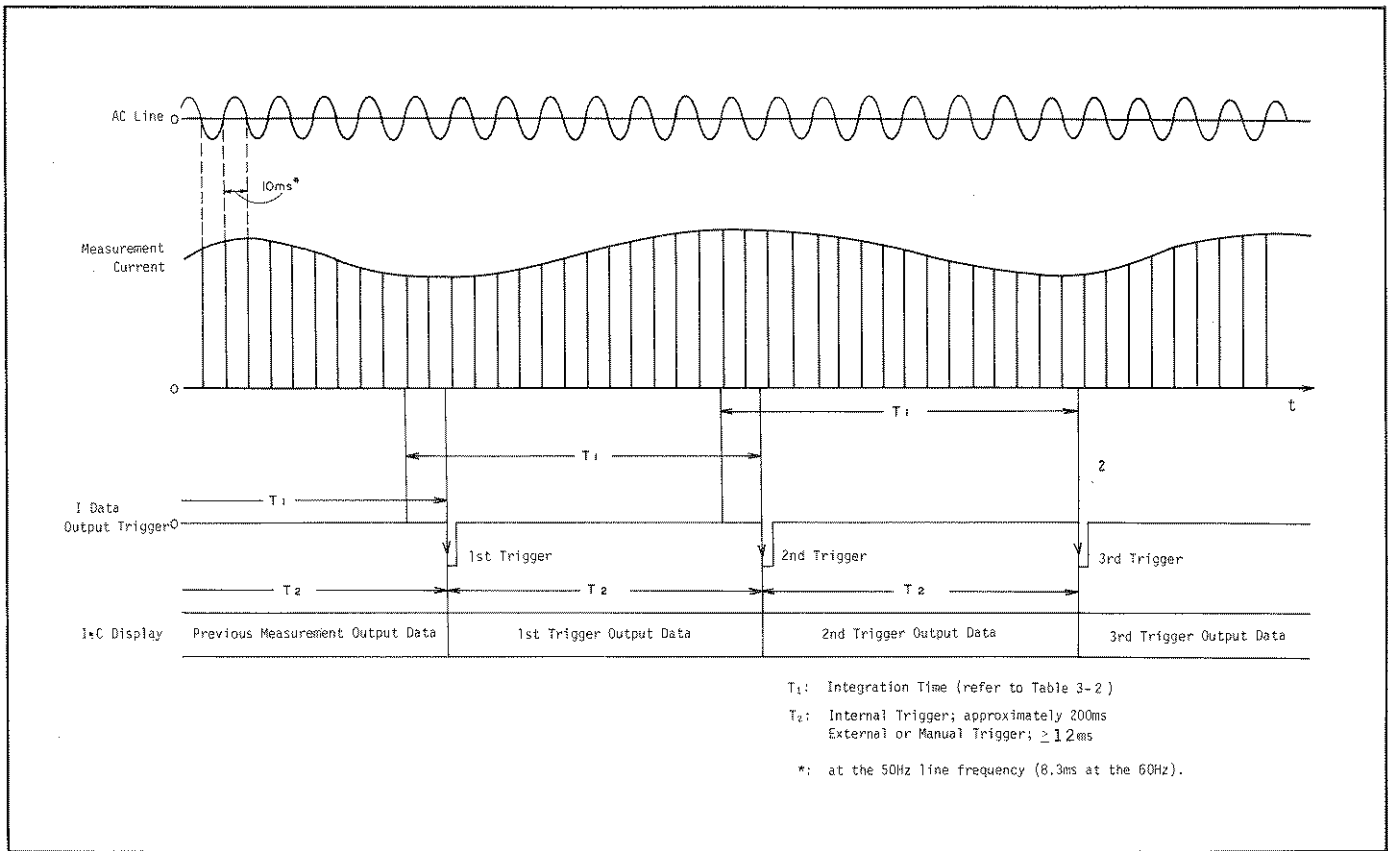

Figure 3-5. Integration Time and Data Output (When FUNCTION is Set to I).

Note

With Option 101 HP-IB Interface, a zero offset can also be done by remote program code "Z" via the HP-IB.

3-25. pA Meter operating instructions (when FUNCTION is set to I).

3-26. The instructions for operating the pA Meter of the 4140A (when FUNCTION is set to I) are given in Figure 3-6.

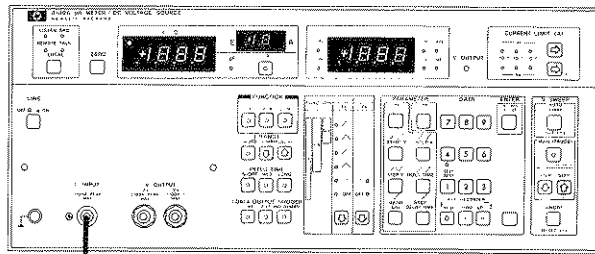

triaxial (male) - triaxial (male) cable
To DUT

PROCEDURE:

- (1) Turn 4140A OFF.
- (2) Connect test lead or test fixture (e.g. triaxial (male) - triaxial (male) cable of 16053A Test Lead (HP Part No. : 16053-61002)) to INPUT connector of 4140A.
- (3) Turn 4140A ON.
- (4) At turn-on Self Test of 4140A is performed once automatically (refer to paragraph 3-5).

Note

The 4140A requires a one hour warm up time to satisfy all specifications in Table 1-1.

- (5) The pA Meter section of 4140A is set automatically as follows:

```

FUNCTION ..... I
I RANGE ..... AUTO
INTEG TIME ..... LONG
I DATA OUTPUT TRIGGER ..... INT
I ZERO OFFSET ..... 0 fA
    
```

- (6) Confirm that the I·C Data Output Trigger lamp is flashing.
- (7) Select desired integration time with the INTEG TIME key on front panel (refer to paragraph 3-18).
- (8) Connect nothing to test leads or to test fixture (open).
- (9) When using the 10^{-12} A measurement range, set I·C DISPLAY to 0.00 ± 10^{-12} A with ZERO offset key (refer to paragraph 3-23).

Note

The measured current on the 10^{-12} A range is a very small value (10^{-12} A \sim 10^{-15} A). Therefore, any leakage current generated by changing test lead connection, test fixture or unknown current source, increases the error of the measurement on the 10^{-12} A range. To avoid this condition, do a ZERO offset after the I·C DISPLAY has settled (allow more than five minutes).



Figure 3-6. pA Meter Section Operating Instructions (when FUNCTION is set to I) (sheet 1 of 2).

- (10) Connect unknown current source to the test lead or test fixture.
- (11) The pA Meter of 4140A will automatically display measured value of unknown.

Note

The display value of a measurement on the 10^{-12} A range may be unstable immediately after connecting unknown current source because of the leakage currents described above.

Note

If the approximate value of the unknown current source is known, the ranging time can be eliminated from the measurement time by setting the current measurement range to hold on the desired range by using the DOWN () or UP () keys.

The equivalent circuit of the pA Meter section in the 4140A is shown below:

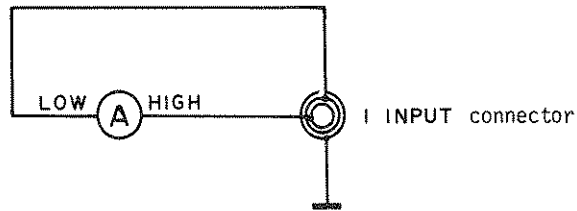





Figure 3-6. pA Meter Section Operating Instructions (when FUNCTION is set to I) (sheet 2 of 2).

3-27. VS (VOLTAGE SOURCE) SECTION.

3-28. The VS section of the Model 4140A operates as two independent programmable voltage sources (VA and VB). Significantly, one of the programmable DC voltage sources (VA) can operate, not only as a programmable DC voltage source, but also as a unique staircase ( , ) or accurate ramp ( , ) generator. In addition, accurate I-V measurements, with the staircase or ramp waves (the timing of either of which can be automatically synchronized between the pA Meter section and the DC Voltage Source section), can be done in the I-V section. In the C-V function, accurate C-V measurements using the ramp wave and calculating the capacitance from the current measurement value and ramp rate (dV/dt), can be done. Paragraphs 3-27 thru 3-42 chiefly describe independent operation as two programmable voltage sources. These instructions should be read even if only an I-V or C-V measurement is to be done. Instructions for I-V measurements are given in paragraphs 3-43 thru 3-48 and for C-V measurements paragraphs 3-49 thru 3-60 should be read.

3-29. VS Section Display.

3-30. An LED display and thirteen LED lamps provide visual data outputs of output voltages and operating parameters. The VS DISPLAY provides a readout of output voltages or operating parameters in a maximum 3-1/2 digit

decimal number with decimal point. If the input parameter value exceeds its limit value an overflow annunciation (O-F) appears. If the 4140A is swept at incorrect parameter settings, an illegal annunciation (ILLE) appears. VA, VB lamps indicate voltage value if the VS DISPLAY is VA or VB. Unit indicator lamps indicate unit of VS DISPLAY. VA OUTPUT lamp is lit when the VS section is operating. CURRENT LIMIT lamps indicate output current limit of VA or VB. If output current goes to limit value, this lamp flashes. The display for the VS section displays the following values in like manner (to those described above):





```

Output Voltage ..... 0.00V ~ ±100.0V
Operating Parameters
  START V/STOP V/ == (DC) . 0.00V ~ ±10.00V
  STEP V ..... 0.01V ~ 10.00V
  HOLD TIME ..... 0.0s ~ 1999s
  STEP DELAY TIME ..... 0.00s ~ 100.0s
  dV/dt (Ramp Rate) ... 0.001V/s ~ 1.00V/s
  CURRENT LIMIT ..... 10-4A, 10-3A, 10-2A
    
```

3-31. VS Section Output Modes.

3-32. The VS section of the 4140A provides two voltage sources, VA (programmable DC Voltage Source/Function Generator) and VB (programmable DC Voltage Source). Each of the voltage sources provide output modes as given in Table 3-3.

Table 3-3. VS Section Output Modes.

| VS | Mode | Description |
|----|---|--|
| VA |  | Simple ramp wave. Output voltage changes continuously (dV/dt) from start voltage to stop voltage. |
| |  | Double ramp wave. Output voltage changes continuously (dV/dt) from start voltage to stop voltage. Successively, output voltage is returned to start voltage at same ramp rate (dV/dt). |
| |  | Single staircase wave. Output voltage changes step-by-step from start voltage to stop voltage. |
| |  | Double staircase wave. Output voltage changes step-by-step from start voltage to stop voltage. Successively, output voltage is returned to start voltage by same step voltage. |
| | == | DC voltage is outputted. |
| | OFF | VA is not operating. |
| VB | == | DC voltage is outputted. |
| | OFF | VB is not operating. |

3-33. VS Section Operating Parameters.

3-34. The VS section of the 4140A provides eight operating parameters as given in Table 3-4. Values of these parameters can be inputted by the following procedures:

- (1) Press desired PARAMETER key.
- (2) Set desired value with DATA keys. VS DISPLAY displays setting value.
- (3) Input displays parameter value with ENTER key. Displayed parameter value is flashed.

Note

With Option 101 HP-IB Interface, parameter values can be set via HP-IB (refer to paragraph 3-83).

Note

If setting parameter value exceeds the setting limit in Table 3-4, VS DISPLAY displays (~~0-F~~) and this value is not inputted.

3-35. Voltage Output and Display of VS.

3-36. The 4140A VS section outputs a voltage and provides for its display by one of the following methods depending on the VS output mode:

Note

When the VS section is operating (when V OUTPUT lamp is lit), no controls or operating parameters can be changed as noted in Table 3-5.



(1) DC (==):

The V_A DC voltage, whose value is set with the V_A (PARAMETER) key, is outputted from the V_A OUTPUT connector with the SET(==) key. Outputted voltage value is displayed on the VS DISPLAY. V_A can be cancelled and set to 0V with RESET(==) key.

Table 3-4. VS Section Operating Parameters.

| Parameter | Description | Setting Limits |
|-----------------|--|---|
| V_A == | DC Voltage. | 10V range: -10.00V ~ +10.00V |
| START V | Start voltage of staircase or ramp wave. | 100V range: -100.0V ~ +100.0V |
| STOP V | Stop voltage of staircase or ramp wave. | |
| STEP V* | Step voltage of staircase or ramp wave. | -10.00V ~ +10.00V |
| HOLD TIME | Hold time for start and stop voltages of staircase or ramp wave. | 0.0s ~ 1999s |
| dV/dt | Ramp wave. | 0.001V/s ~ 1.000V/s |
| STEP DELAY TIME | Delay time for each voltage of staircase or ramp wave. | 0.00s ~ 100.0s |
| V_B == | DC Voltage. | 10V range: -10.00V ~ +10.00V 100V range: -100.0V ~ +100.0V |



* Step voltage of the ramp wave means displayed step voltage of VS DISPLAY. (STEP V)/(dV/dt) must be more than 50ms. Step voltage value automatically rises to 0.1V resolution when absolute value of outputted voltage is over 10 volts.

(2) Staircase Wave ( , ):
The V_A output voltage is swept with set operating parameters (START V, STOP V, STEP V, HOLD TIME, and STEP DELAY TIME) There are two sweep control methods, auto sweep and manual sweep:

① Auto Sweep:



The V_A output voltage is swept automatically according to the set operating parameters when the AUTO START key is pushed. The relation between output voltage and its display is given in Figures 3-7 and 3-8. The V_A output sweep can be stopped halfway and the operating parameters (except for START V/STOP V and integration time) can be changed. When the V_A output sweep is completed, V_A is automatically set to 0V. The V_A output sweep can be cancelled and set to 0V at the halfway point with ABORT key.

② Manual Sweep:

The V_A output voltage is set to manual sweep mode with MAN key. The V_A output voltage is swept at its operating parameters (except for HOLD TIME/ STEP DELAY TIME) in this mode using Step Down () and Step Up () keys. Outputted voltage is displayed on VS DISPLAY.

Note

The MAN (PAUSE) key changes the sweep mode from auto (LED lamp is not lit) to manual (LED lamp is lit) or from manual to auto.

(3) Ramp Wave ( , ):
The V_A output voltage is swept automatically at its operating parameters (START V, STOP V, STEP V, HOLD TIME and dV/dt) when the AUTO START key is pushed. The relationship between output voltage and its display is given in Figures 3-9 and 3-10. The V_A output sweep can be stopped halfway, at which time its operating parameters (except for START V/STOP V) can be changed. When the V_A output sweep is completed, V_A is automatically set to 0V. The V_A output sweep can be cancelled and set to 0V at the halfway point with the ABORT key.

Note

The V_A output voltage can be set to START V and initially held at this voltage with the PAUSE key. After the desired "wait" time, V_A output sweep can be restarted.

Note











VS DISPLAY will display V_A output voltage during the time that VS section is outputting voltage (except when V_A is set to OFF). But when V_B is set to  , both V_A and V_B sources are outputting voltages at the same time. V_B output voltage can be monitored with V_B key.

Table 3-5. Inhibition of Controls and Operating Parameters (When VS Section is Operating).

| VS Sweep Mode | Controls | | | | Operating Parameters | | | | | | | | |
|--|----------|-------------|----------------|----------------|---|---|---|---|---|---|---|---|---|
| | FUNCTION | INTEG. TIME | V _A | V _B |  |  |  |  |  |  |  |  |  |
| AUTO,  (DC) | x | x | x | x | x | x | x | x | x | x | x | x | x |
| MANUAL (PAUSE) | x | △ | x | x | ○ | ○ | x | x | ○ | ○ | ○ | ○ | ○ |

○: Can be changed.
△: Can not be changed during ramp wave.
x: Can not be changed.

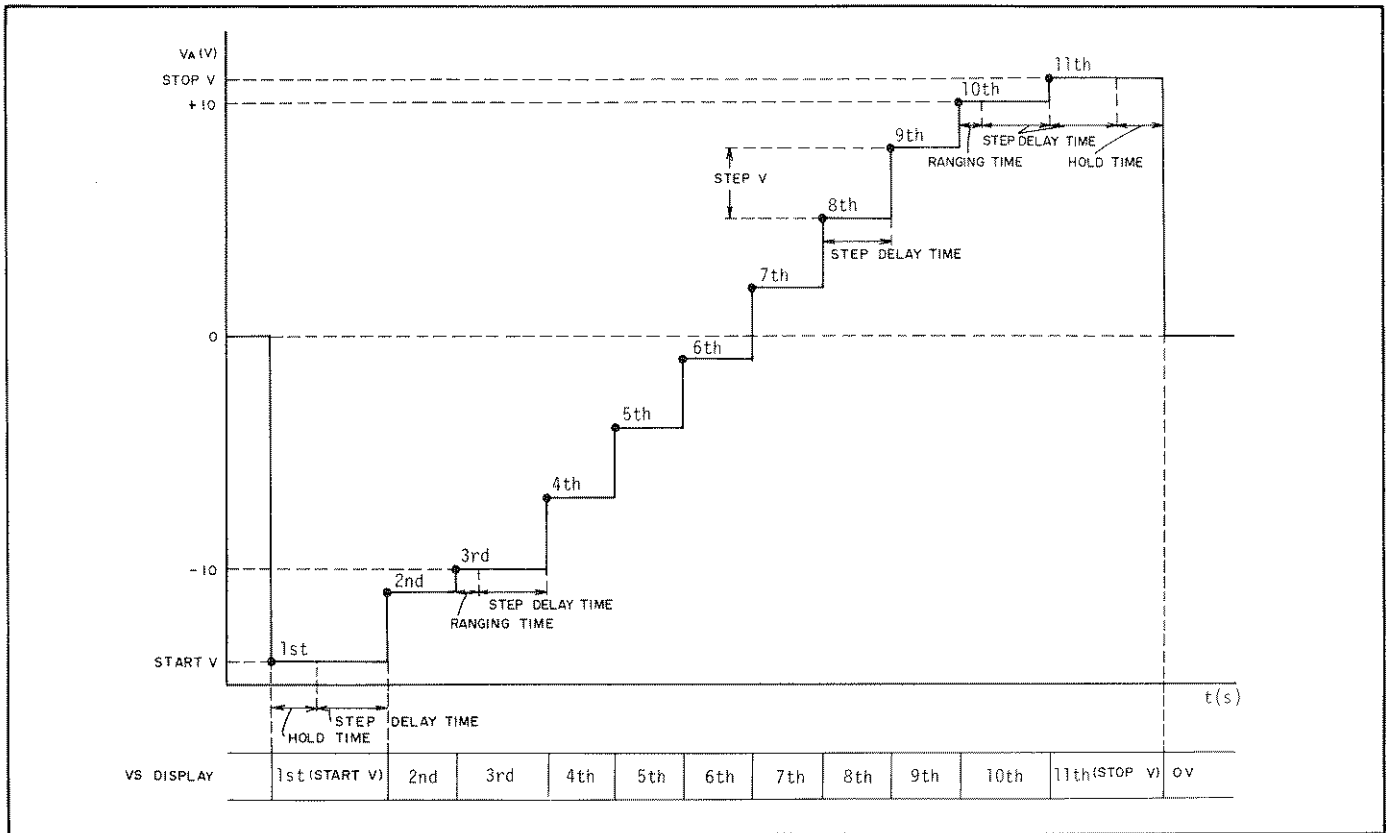

Figure 3-7 Relationship between Output Voltage and Display for \lrcorner (Single Staircase Wave).

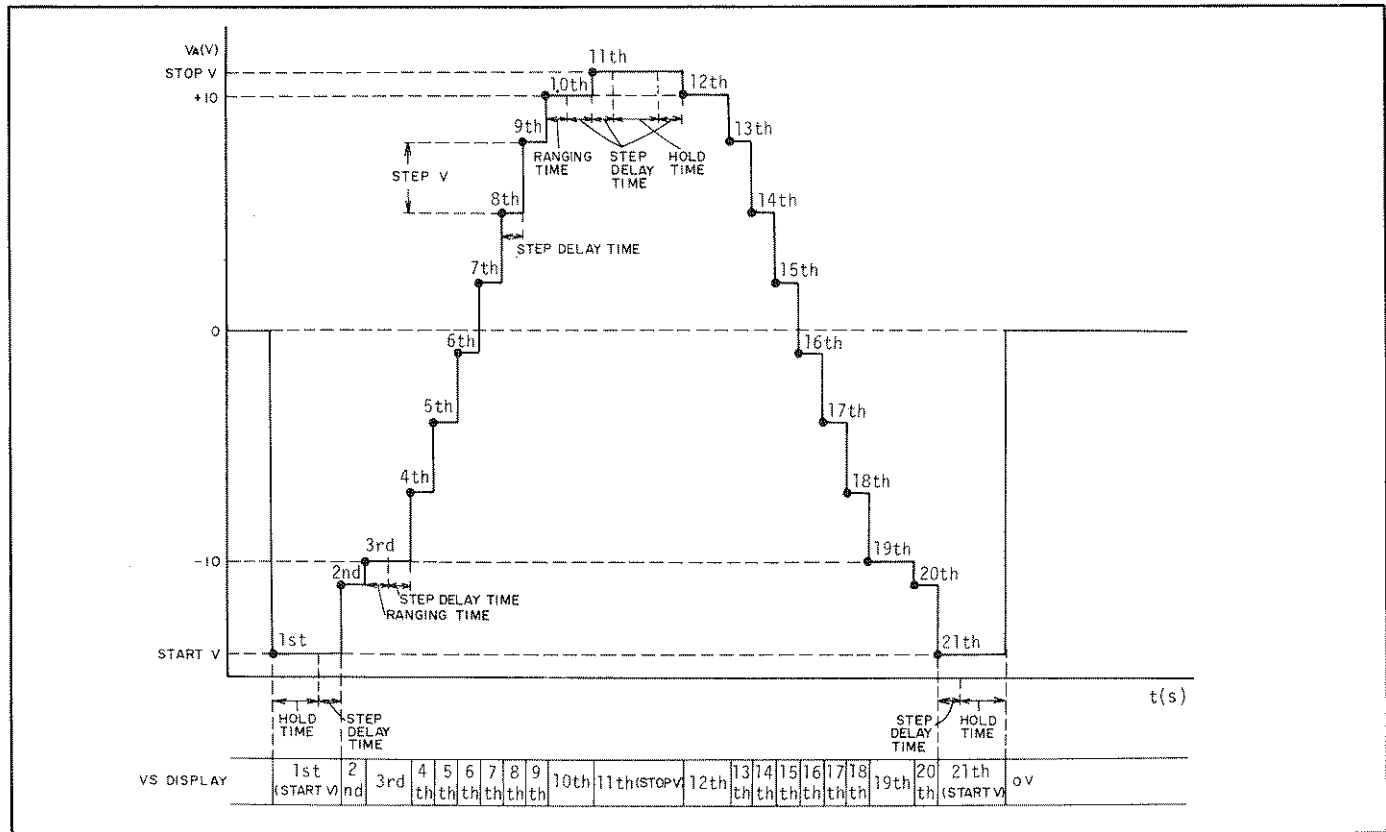

Figure 3-8. Relationship between Output Voltage and Display for \lrcorner (Double Staircase Wave).

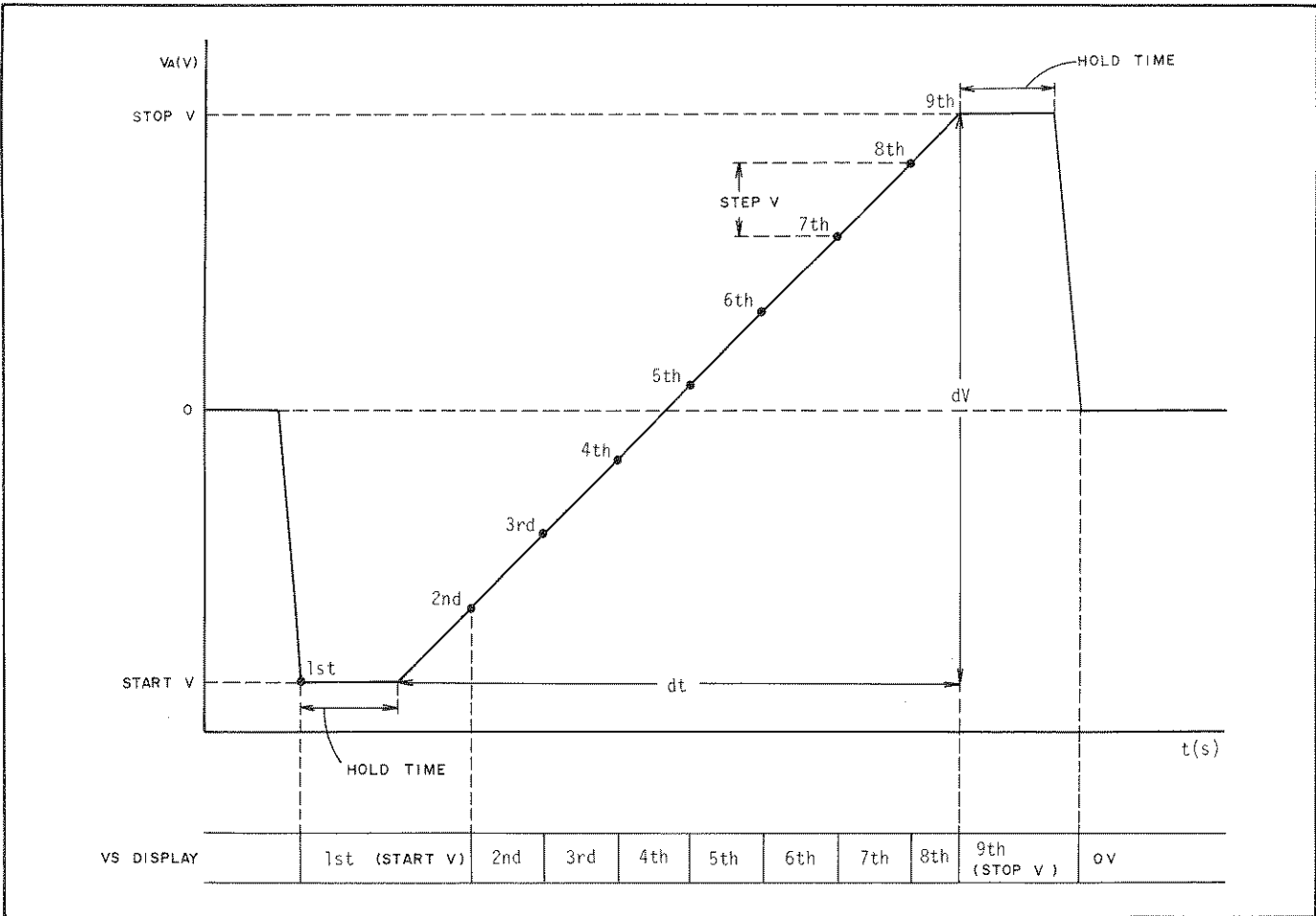

Figure 3-9. Relationship between Output Voltage and Display for \nearrow (Single Ramp Wave).

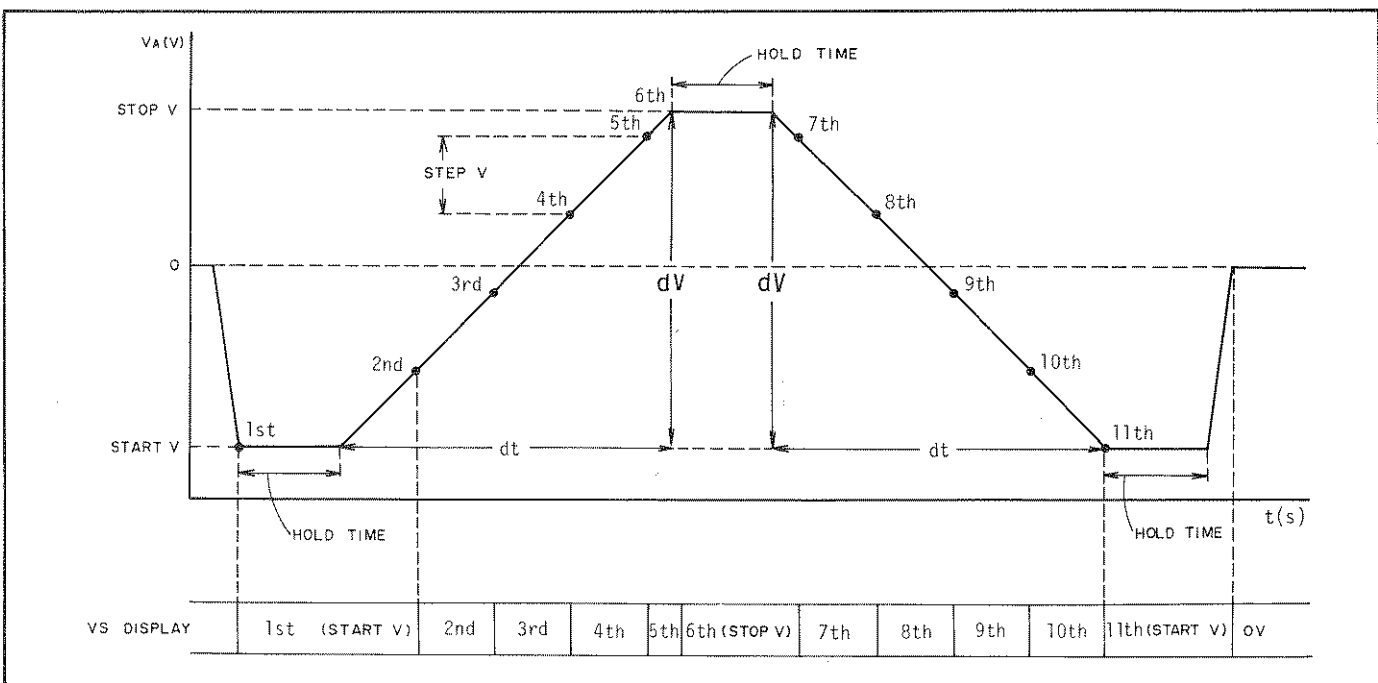

Figure 3-10. Relationship between Output Voltage and Display for \wedge (Double Ramp Wave).

3-37. Output Voltage Range.

3-38. The VS section of the 4140A provides two output voltage ranges: an x1 range (0.00V ~ 10.00V at the 0.01V step) and an x10 range (0.0V ~ 100.0V in 0.1V steps). Range changing is done automatically by the following methods (depending on VS output mode):

(1) DC == (VA and VB):

Output voltage range is individually selected depending on the value of the parameter (VA == or VB ==). x1 range is selected when VA == (VB ==) is 0.00V ~ 10.00V. x10 range is selected when VA == (VB ==) is -100.0V ~ -10.1V or +10.1V ~ +100.0V.

(2) Staircase Wave (\square , \square):

Output voltage range changes automatically from x1 range to x10 range or from x10 range to x1 range at 10.00V. If STEP V is set to 0.01V resolution, step voltage value is raised automatically to 0.1V resolution on x10 range.

Note

When output voltage range is changed from x1 range to x10 range or from x10 range to x1 range, output voltage is always set to +10.00V (or -10.00V) as shown in Figure 3-11. The ranging time needed is approximately 20ms (refer to Figures 3-7 and 3-8).

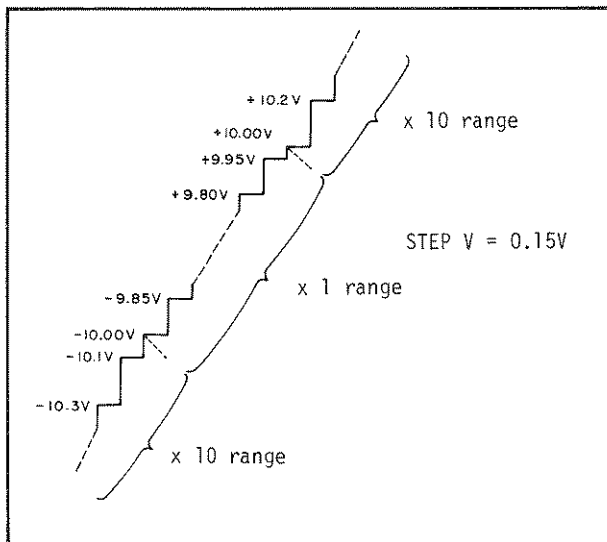

Figure 3-11. Output Voltage Range of Staircase Wave.

(3) Ramp Wave (\sloperight , \slopleft):

Output voltage range selected depends on parameter values (START V and STOP V). x1 range is selected with absolute values of START V and STOP V up to 10 volts. x10 range is selected when absolute values of START V or STOP V are over 10 volts.

3-39. Current Limit.

3-40. The VS section of the 4140A can be used not only as independently programmable DC voltage sources/function generator, but also as a function generator synchronized to the pA Meter section for I-V/C-V measurements. I-V/C-V measurements are chiefly used to make characteristic measurements and analyses of semiconductor devices (e.g. diodes, FET's, etc.) or of electronic devices (e.g. capacitors, pc boards, cables, etc.). Some of these devices may be damaged by excessive current. Each of the programmable DC voltage sources (VA and VB) has a current limiter to avoid damage to the DUT by excessive current. The individual current limiters can be set for the current limit value ($10^{-4}A$, $10^{-3}A$ or $10^{-2}A$). If the output current goes to the limit value, an LED lamp on the front panel flashes and its voltage source (VA or VB) outputs current only at this maximum value. Output voltage value of the VS DISPLAY is then invalid.

3-41. VS Section Operating Instructions.

3-42. Instructions for operating the VS section of the 4140A (when FUNCTION is set to I) are given in Figure 3-12.

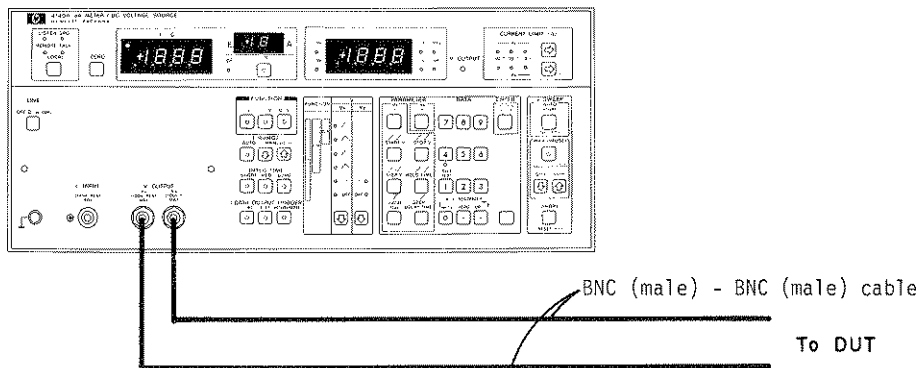

PROCEDURE

- (1) Turn 4140A OFF.
- (2) Connect test leads or test fixture (e.g. BNC (male) - BNC (male) cables of 16053A Test Lead (HP Parts No.: 16053-61003)) to V OUTPUT connectors of 4140A.
- (3) Turn 4140A ON.
- (4) At turn-on, Self Test of 4140A is performed once automatically (refer to paragraph 3-5).

Note

The 4140A requires a one hour warm up time to satisfy all specifications in Table 1-1.

- (5) The VS section of 4140A is set automatically as follows:

```

FUNCTION ..... I
VA ..... 
VB ..... OFF
PARAMETER ..... all parameters are 0
VA CURRENT LIMIT ..... 10-4A
VB CURRENT LIMIT ..... 10-4A
    
```

- (6) Select desired VA and VB output modes with VS Mode Select keys on front panel (refer to paragraph 3-31).
- (7) Input values for VA operating parameters depend on selected VA output modes as follows (refer to paragraph 3-33):

```

 : VA=== .
 ,  : START V, STOP V, STEP V, HOLD TIME, STEP DELAY TIME.
 ,  : START V, STOP V, STEP V, HOLD TIME, dV/dt.
    
```

- (8) Input value for VB === when VB will also be used.
- (9) Set current limit values for VA and VB with CURRENT LIMIT Select keys (refer to paragraph 3-39).

Figure 3-12. VS Section Operating Instructions (when FUNCTION is set to I) (sheet 1 of 2).

- (10) Start voltage output with following keys for each VA setting (refer to paragraph 3-35):

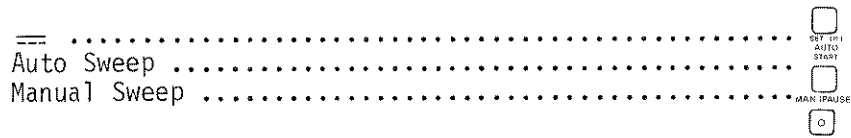

- (11) During the time that VS section is outputting voltage, the V OUTPUT lamp is lit.

Note

VS DISPLAY will display VA output voltage during the time that VS section is outputting voltage (except when VA is set to OFF). But when VB is set to ==, both VA and VB sources are outputting voltages at the same time. VB output voltage can be monitored with VB == key.

The equivalent circuit of the VS (Voltage Source) section in the 4140A is shown below:

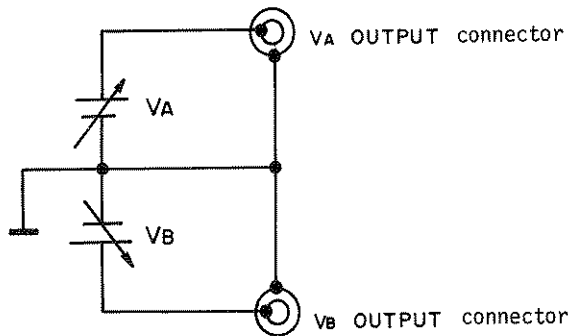

WARNING

100V MAX MAY EXIST ON THE CENTER CONDUCTOR OF BNC (FEMALE) CONNECTORS OF VA AND VB.

- (12) If VA is set to Auto Sweep, VA and VB are automatically set to abort condition (0V) when auto sweep is completed. When VA is set to Manual Sweep or ==, VA and VB can be set to abort condition (0V) with ABORT (RESET) key.





Note

VA auto sweep can be stopped at the halfway point with the ABORT key.



Figure 3-12. VS Section Operating Instructions (when FUNCTION is set to I) (sheet 2 of 2).

3-43. I-V MEASUREMENT

Note

3-44. The Model 4140A can automatically synchronize measurement timing between the pA Meter section and the VS (Voltage Source) section when the FUNCTION is set to I-V. Accurate I-V measurements with the staircase ( , ) or ramp ( , ) waves can be made by taking advantage of the variable digital integration (moving average method) which is described in paragraph 3-18. Operations of the I-V measurement are described in paragraphs 3-43 thru 3-48. For basic operational instructions of the pA Meter section, refer to paragraphs 3-12 thru 3-26 and for the VS section refer to paragraphs 3-27 thru 3-42.

When FUNCTION is changed to I-V, the invalid data annunciation () is displayed on the I·C DISPLAY.

(2) Ramp wave ( , ):



Output voltage of the ramp wave changes continuously at a specific ramp rate (dV/dt) so that digital integration (for each voltage step) is done using the raw current measurement data before and after VA goes to its step voltage (in equal periods above and below the step voltage as fixed by the integration time). Therefore, the relationship between the I-V measurement and its data output (to the I·C DISPLAY and VS DISPLAY) for a ramp wave will be as shown in Figures 3-15 and 3-16.

3-45. I-V Measurement Data Output.

Note

3-46. Measurement timing is automatically synchronized between the pA Meter section and the VS section in I-V measurements to assure that the measurement is taken at the correct timing. The methods for taking raw current measurement data for digital integration of the pA Meter section changes dependent on the output modes of the VS section as follows:

When raw current measurement data for digital integration is short, an invalid data annunciation () is displayed on the I·C DISPLAY. This annunciation always appears just after changing FUNCTION or after a parameter(s) is changed, or at the START V. If the STEP V is set to a small value when the ramprate (dV/dt) is set to a fast value and the integration time is set to LONG, this annunciation is also appears at several step voltage just after START V.

(1) Staircase wave ( , ):

Digital integration (refer to paragraph 3-18) or each step measurement is done, using the raw current measurement data, after VA goes to its step voltage. Therefore, the relationship between the I-V measurement and its data output (to the I·C DISPLAY and VS DISPLAY for a staircase wave will be as shown in Figures 3-13 and 3-14.

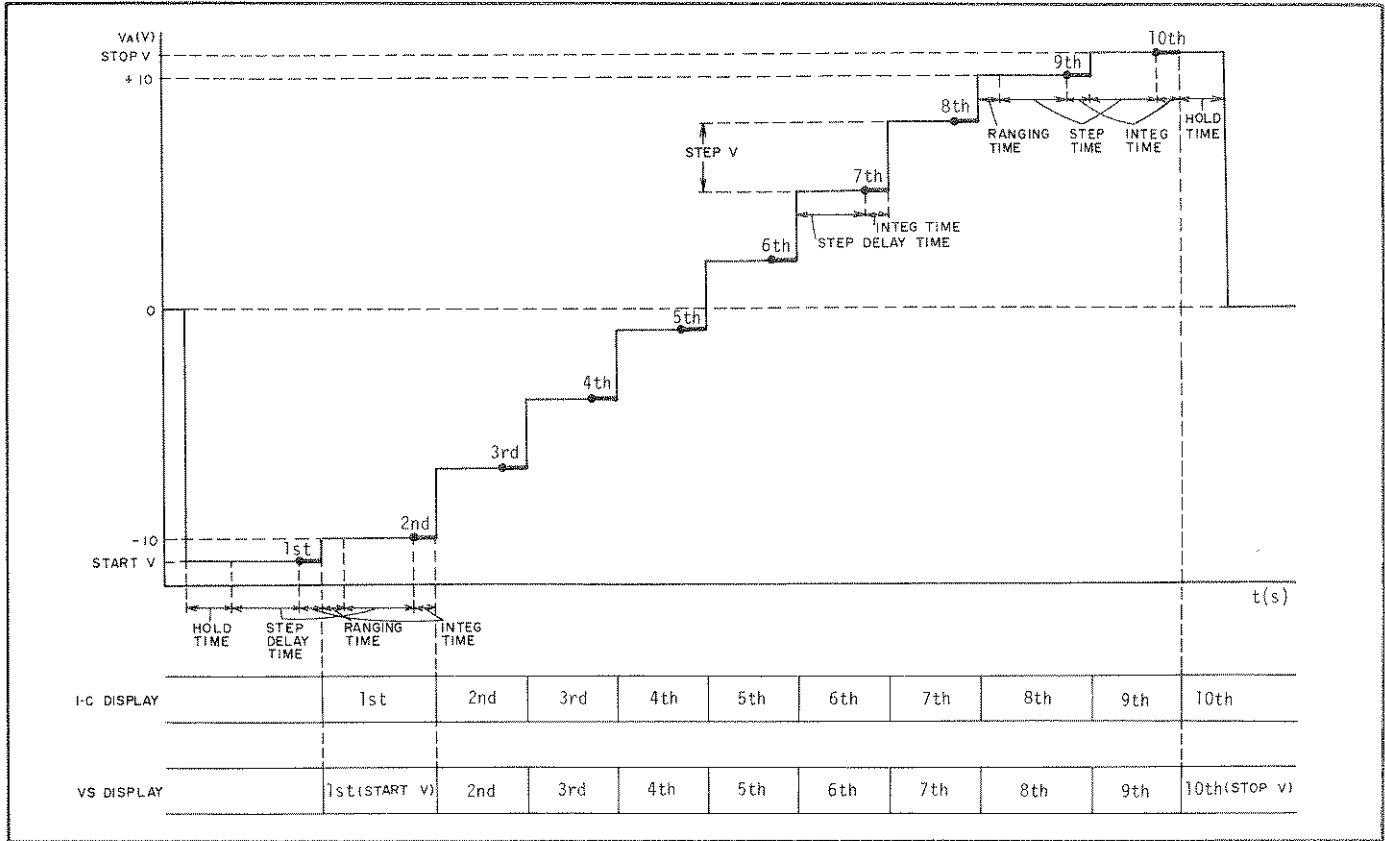

Figure 3-13. Relationship between I-V Measurement and Displays for \square (Single Staircase Wave).

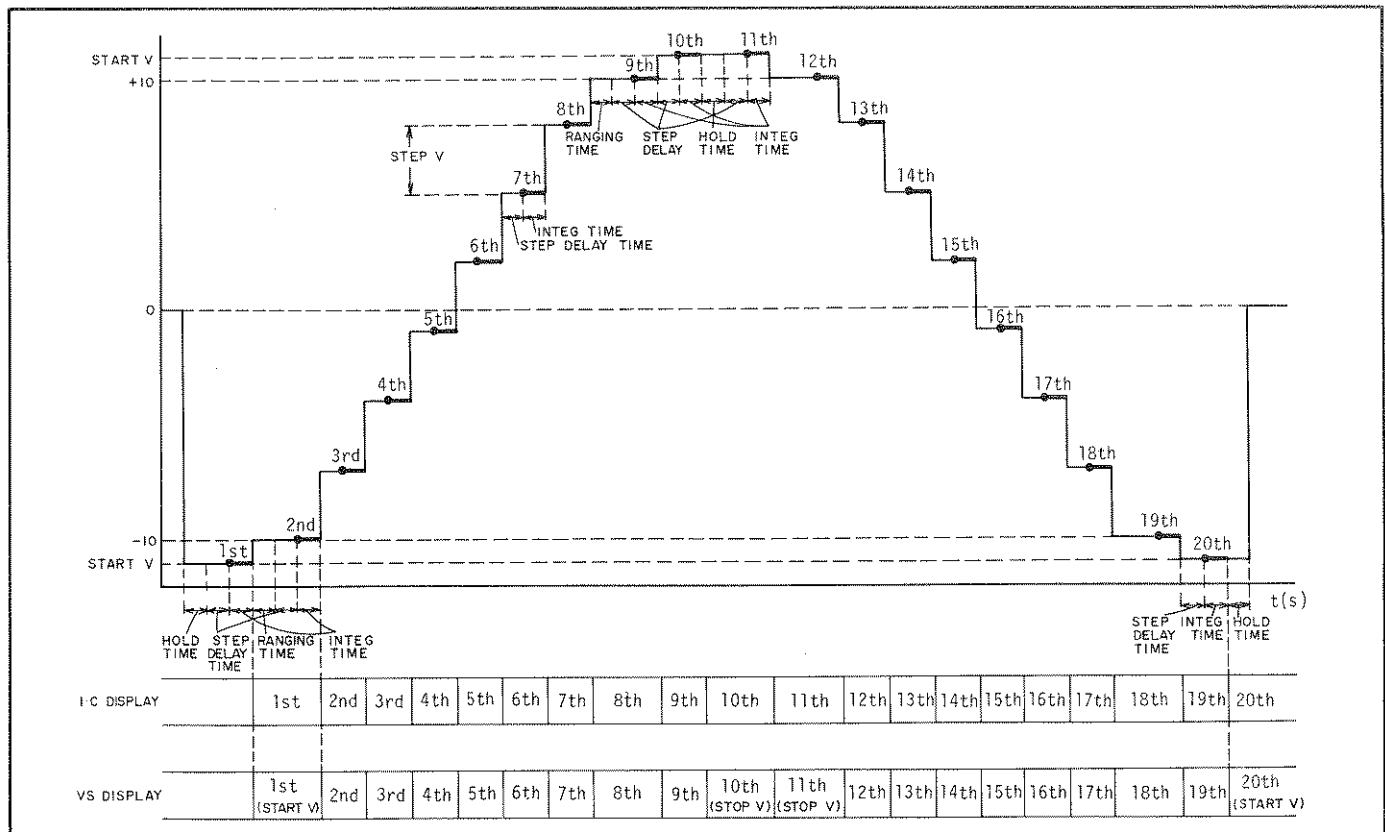

Figure 3-14. Relationship between I-V Measurement and Displays for \square (Double Staircase Wave).

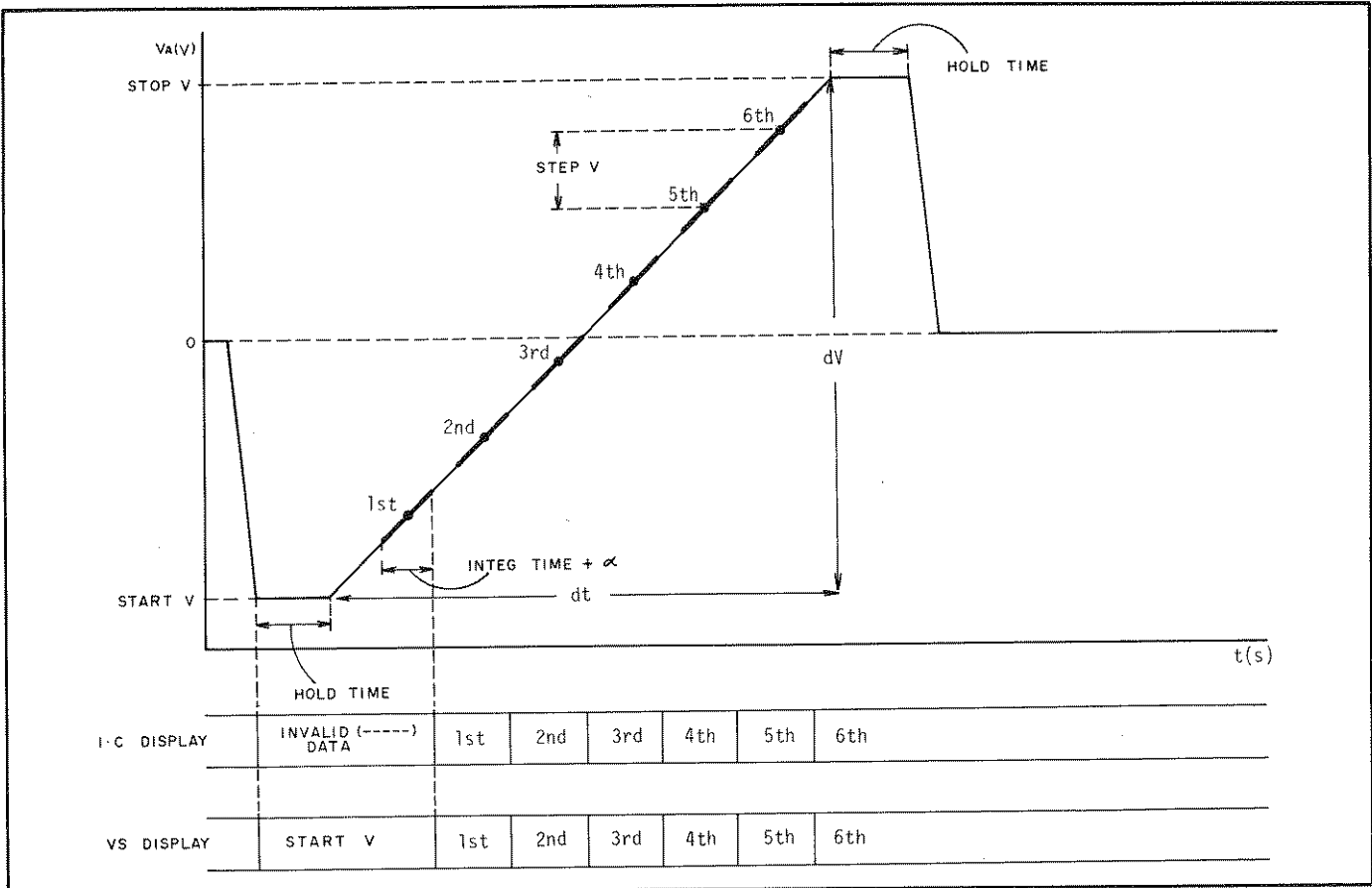

Figure 3-15. Relationship between I-V Measurement and Displays for \nearrow (Single Ramp Wave).

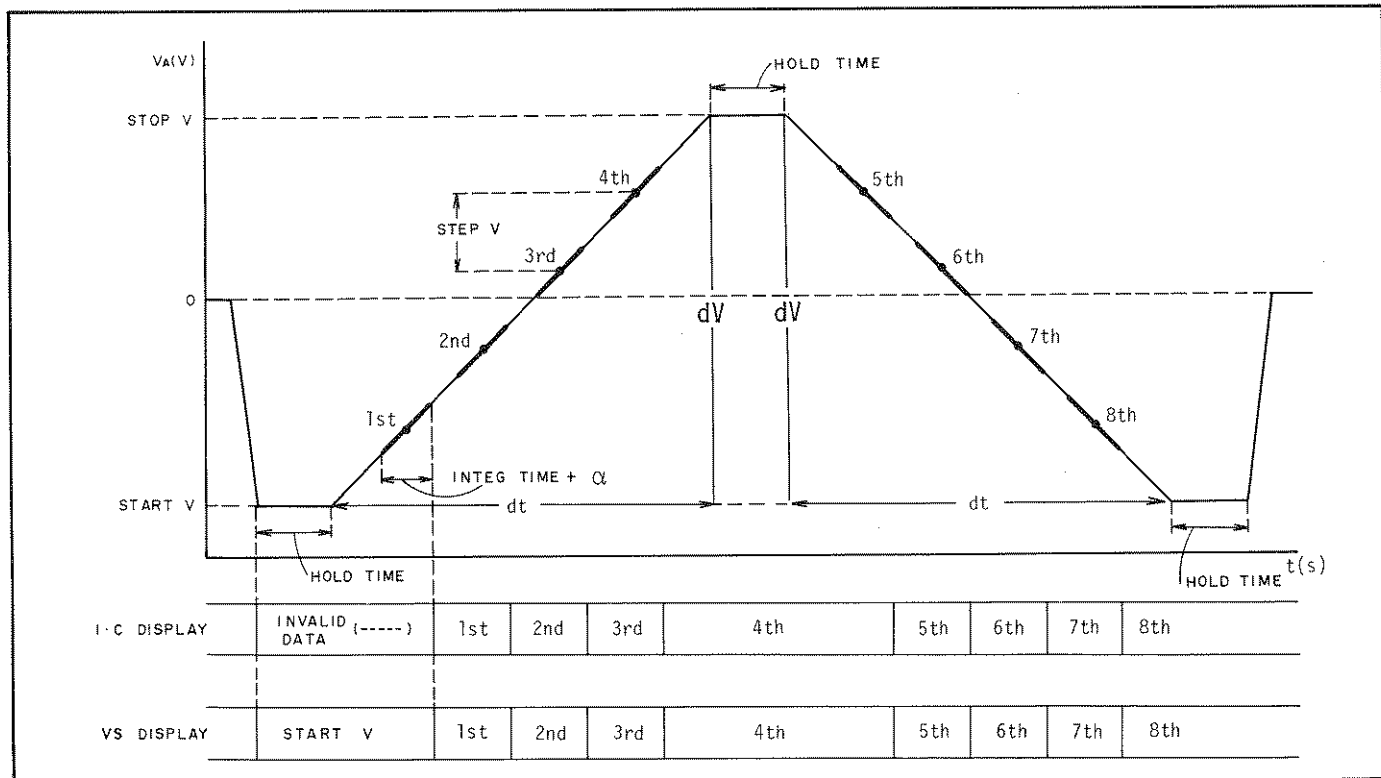

Figure 3-16. Relationship between I-V Measurement and Displays for \wedge (Double Ramp Wave).

3-47. I-V Measurement Operating Instructions.

3-48. Operating instructions for taking an I-V measurement are given in Figure 3-17.

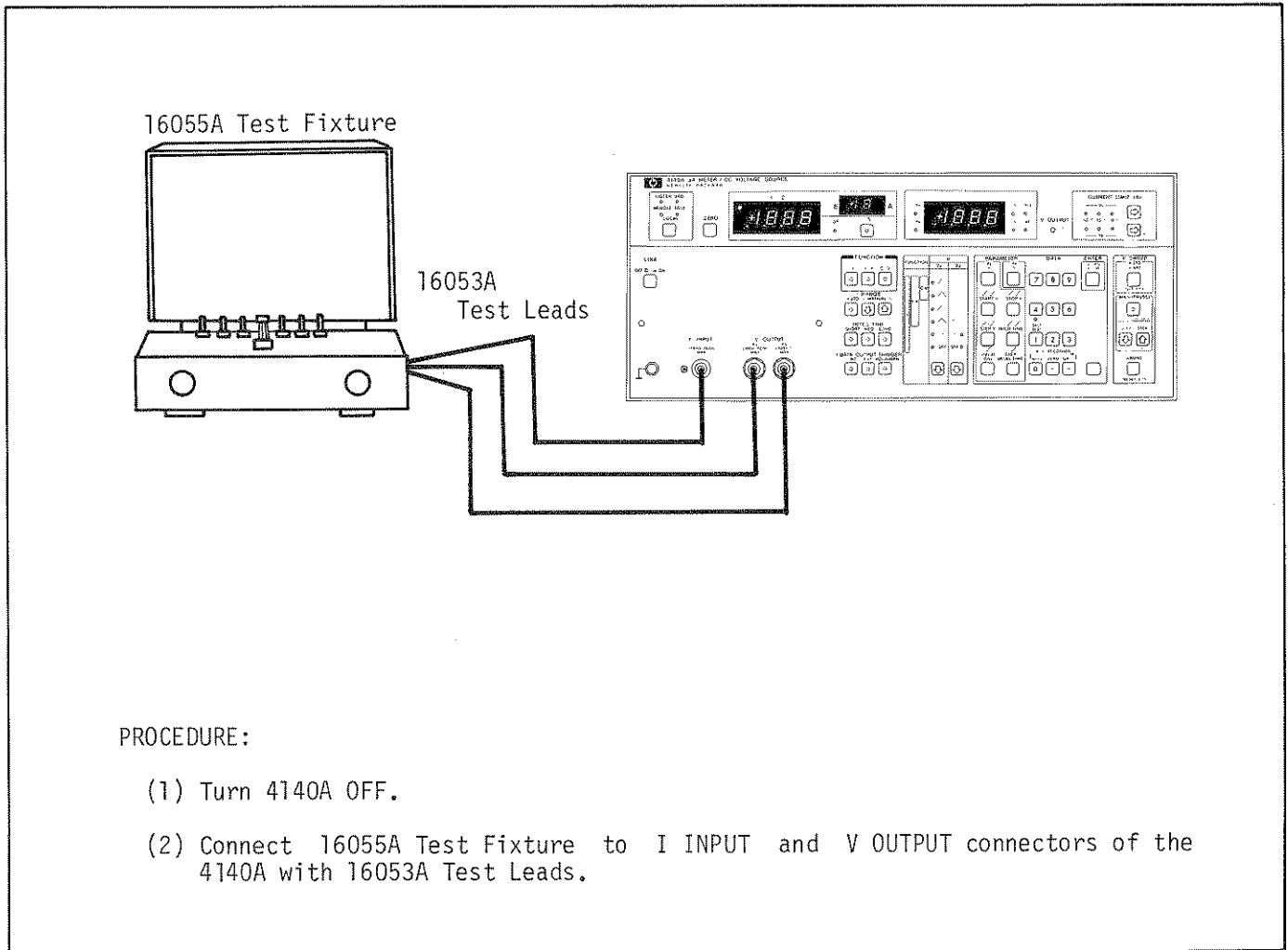

Figure 3-17. I-V Function Operating Instructions (sheet 1 of 4).

16055A Test Fixture

The 16055A can be used for stable pA current measurements of general devices with the electrostatic/light-shielded hood. DUT can be connected easily with alligator-clips or with the TO-5 type sockets which are furnished accessories of the 16055A (refer to Table 1-4 for photos and part numbers of accessories).

LOW lead connection of pA Meter section in the 4140A is selected with 16055A LOW LEAD CONNECTION select switch as follows:

◦ V_A , V_B :

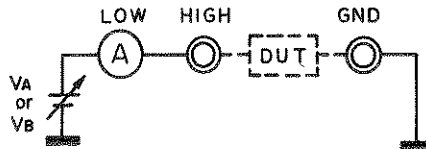

◦ GND :

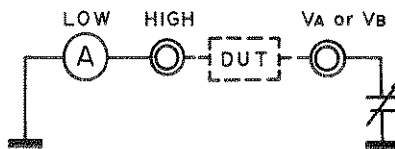

CAUTION

FOR SAFETY, THE 16055A SETS VOLTAGE SOURCES (V_A , V_B AND EXTERNAL) ARE SET TO OFF BY A MICRO-SWITCH WHEN HOOD IS OPENED (AS ILLUSTRATED IN FIGURE AT RIGHT). MICRO-SWITCH CONTACTS ARE LOW RESISTANCE CONTACTS. HOWEVER, THIS RESISTANCE INCREASES WITH TIME. TO CLEAN CONTACT, DRIVE A CURRENT OF 0.1 TO 1A THROUGH CONTACT. OPEN AND CLOSE CONTACTS ONCE OR TWICE. THE HEAT AND ARCING WILL CLEAN CONTACTS.

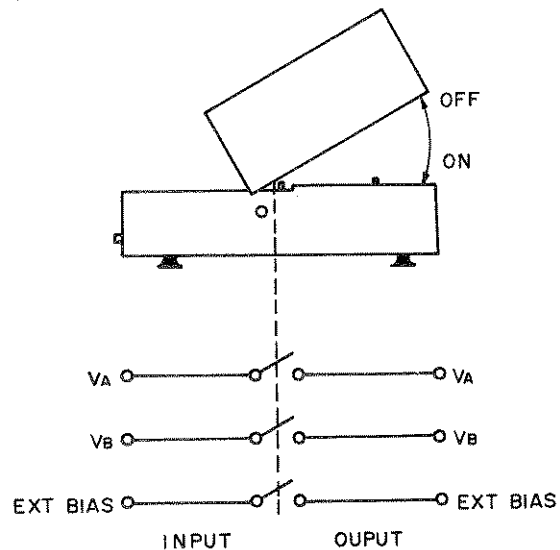

WARNING

DO NOT USE 16055A WITH HP MODEL 16054A CONNECTION SELECTOR. A HAZARDOUS VOLTAGE MAY EXIST ON LOW LEAD TERMINAL EVEN IF 16055A LOW LEAD CONNECTION SELECT SWITCH IS SET TO GND POSITION WHEN 16054A LOW LEAD SELECT SWITCH IS SET TO V_A OR V_B POSITION.

Figure 3-17. I-V Function Operating Instructions (sheet 2 of 4).

- (3) Turn 4140A ON.
- (4) At turn-on, Self Test of 4140A is performed once automatically (refer to paragraph 3-5).

Note

The 4140A requires a one hour warm up time to satisfy all specifications in Table 1-1.

- (5) The 4140A is automatically set as follows:

```

FUNCTION ..... I
I RANGE ..... AUTO
INTEG TIME ..... INT
VA ..... 
VB ..... OFF
PARAMETER ..... all parameters are 0
I ZERO OFFSET ..... 0 fA
C ZERO OFFSET ..... 0 pF
VA CURRENT LIMIT ..... 10-4A
VB CURRENT LIMIT ..... 10-4A

```

- (6) Confirm that the I·C Data Output Trigger lamp is flashing.
- (7) Select desired integration time with the INTEG TIME keys on front panel (refer to paragraph 3-18).
- (8) Connect nothing to 16055A (Open).
- (9) When using the 10⁻¹²A measurement range, set I·C DISPLAY to 0.00×10 A with ZERO offset key (refer to paragraph 3-23).
- (10) Set FUNCTION to I-V.
- (11) Select desired current measurement range with I RANGE keys (refer to paragraph 3-16).
- (12) Select desired VA and VB output modes with VS Mode Select keys on front panel (refer to paragraph 3-31).
- (13) Input values for VA operating parameters depending on selected VA output mode as follows (refer to paragraph 3-33):







 ,  : START V, STOP V, STEP V, HOLD TIME, STEP DELAY TIME.
 ,  : START V, STOP V, STEP V, HOLD TIME, dv/dt.
- (14) Input value for VB = (when VB is also to be used).
- (15) Select current limit values of VA and VB with CURRENT LIMIT Select keys (refer to paragraph 3-39).
- (16) Select Low lead connection of pA Meter-section in the 4140A with 16055A LOW LEAD CONNECTION Select switch depending on kind of measurement.

Figure 3-17. I-V Function Operating Instructions (sheet 3 of 4).



3-49. C-V MEASUREMENT.

3-50. The Model 4140A can automatically synchronize measurement timing between the pA Meter section and the VS (Voltage Source) section to make Quasi-Static C-V characteristics measurements when the FUNCTION is set to C-V. Accurate C-V measurements, using the precise ramp (, ) waves and the high stability pA Meter with its 10^{-15} A max. resolution, can be made by taking advantage of the instruments' variable digital integration (moving average method) described in paragraph 3-18. The capacitance value is calculated from the following formula:

$$C = \frac{I \text{ (measured current value)}}{dV/dt \text{ (ramp rate)}}$$



C-V measurement operations are described in paragraphs 3-49 thru 3-60. For basic operational instructions of the pA Meter section, refer to paragraphs 3-12 thru 3-26 and for operation of the VS section refer to paragraphs 3-27 thru 3-42.

3-51. C-V Measurement Data Output



3-52. C-V measurements measurement timing is automatically synchronized between the pA Meter and the accurate ramp wave (, ) by the VS section to assure that the measurements are taken at the correct times. Output voltage of the ramp wave changes continuously at a specific ramp rate (dV/dt) so that digital integration (for each voltage step) is done using the raw current measurement data before and after V_A goes to its step voltage (in equal periods above and below the step voltage as fixed by the integration time). Therefore, the relationship between the C-V measurement and its data output (to the I·C DISPLAY and VS DISPLAY) will be as shown in Figures 3-18 and 3-19.

Note

When the raw current measurement data for digital integration is short, an invalid data annunciation () is displayed on the I·C DISPLAY. This annunciation always appears just after changing FUNCTION, after a parameter(s) is changed, or at the START V. If the STEP V is set to a small value when the ramp rate (dV/dt) is set to a fast value and the integration time is set to LONG, this annunciation also appears at several

step voltages just after START V. In a C-V measurement, lesser significant digit data of the calculated capacitance is displayed when the number of significant digits for the current measurement data is less than the total digits of the calculated capacitance. (refer to Figure 3-20). In an I·C DISPLAY, the lesser significant digit data is represented by a small zero figure () to differentiate it from the more significant digit which is represented by a large zero () as shown in Figure 3-4.

3-53. C-V Measurement Range

3-54. For a C-V measurement, the 4140A provides two measurement ranges, 0.0pF~89.9pF in 0.1pF steps and 190pF~1900pF in 1pF steps. Range changing is done automatically. In addition, a current measurement range, which is an actual measurement range, is provided as in I or I-V measurements (refer to paragraph 3-16). If the I·C DISPLAY count is over 1900 counts when the current measurement range is held, the I·C DISPLAY displays an () annunciation as in I or I-V measurements. If the calculated capacitance value is over 1900 pF, the I·C DISPLAY displays an () annunciation. If the calculated capacitance value in percent is over 199.9% when the I·C DISPLAY is set to percent display, the I·C DISPLAY displays an () annunciation. The relationship between the calculated capacitance value and current measurement ranges are shown in Figure 3-20. To make C-V measurements on the most suitable current measurement range, use the following procedures:

- (1) Set the 4140A for C-V measurement (refer to Figure 3-23).
- (2) Set FUNCTION to I-V.
- (3) At this time, the 4140A panel control functions are automatically set as follows (refer to paragraph 3-8):

I RANGE AUTO
VA 

- (4) Select desired V_A output mode with V_A Mode Select key.
- (5) Make a I-V measurement.
- (6) Set current measurement range to maximum range for an I-V measurement.

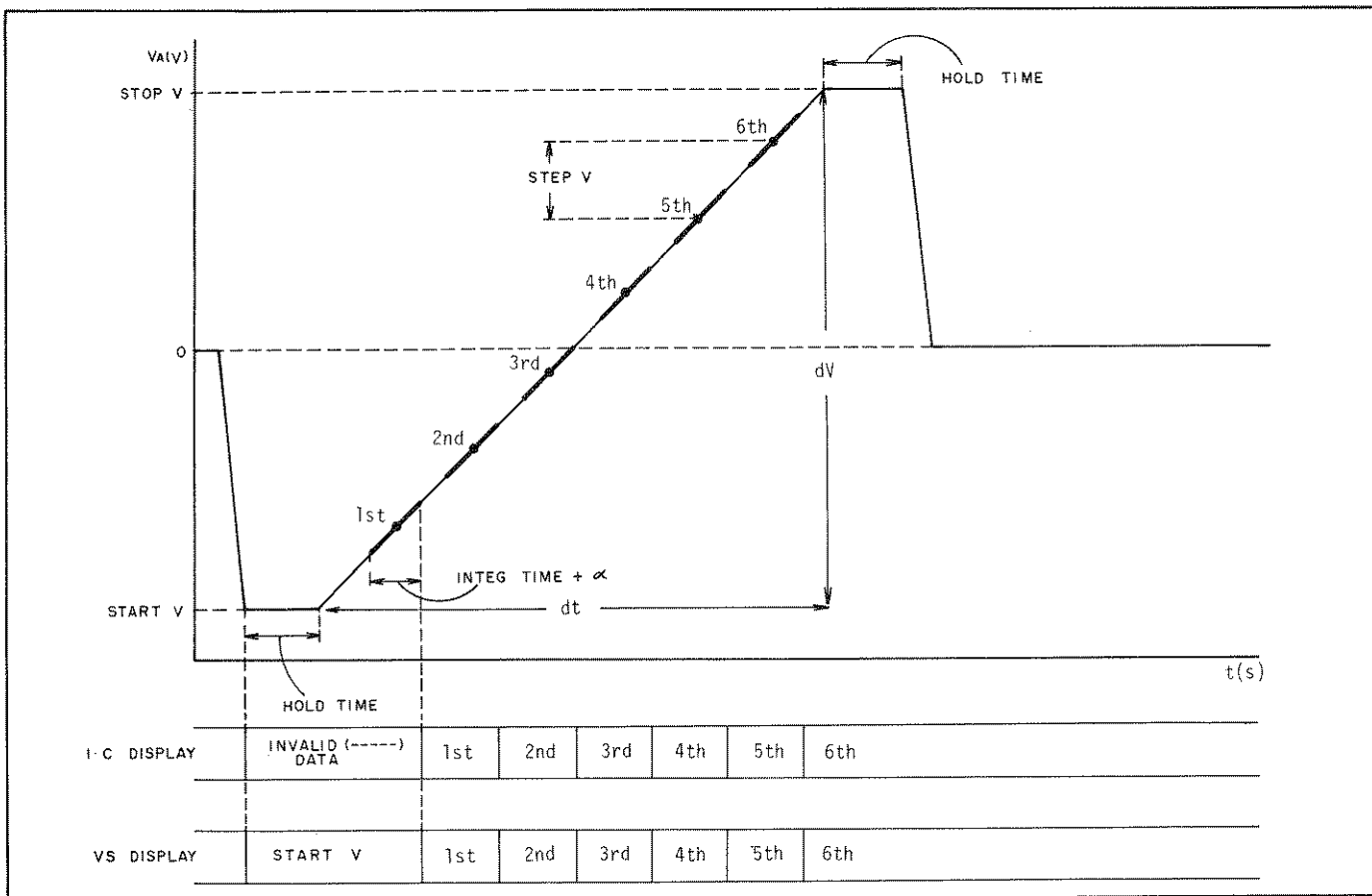

Figure 3-18. Relationship between C-V Measurement and Displays for \nearrow (Single Ramp Wave).

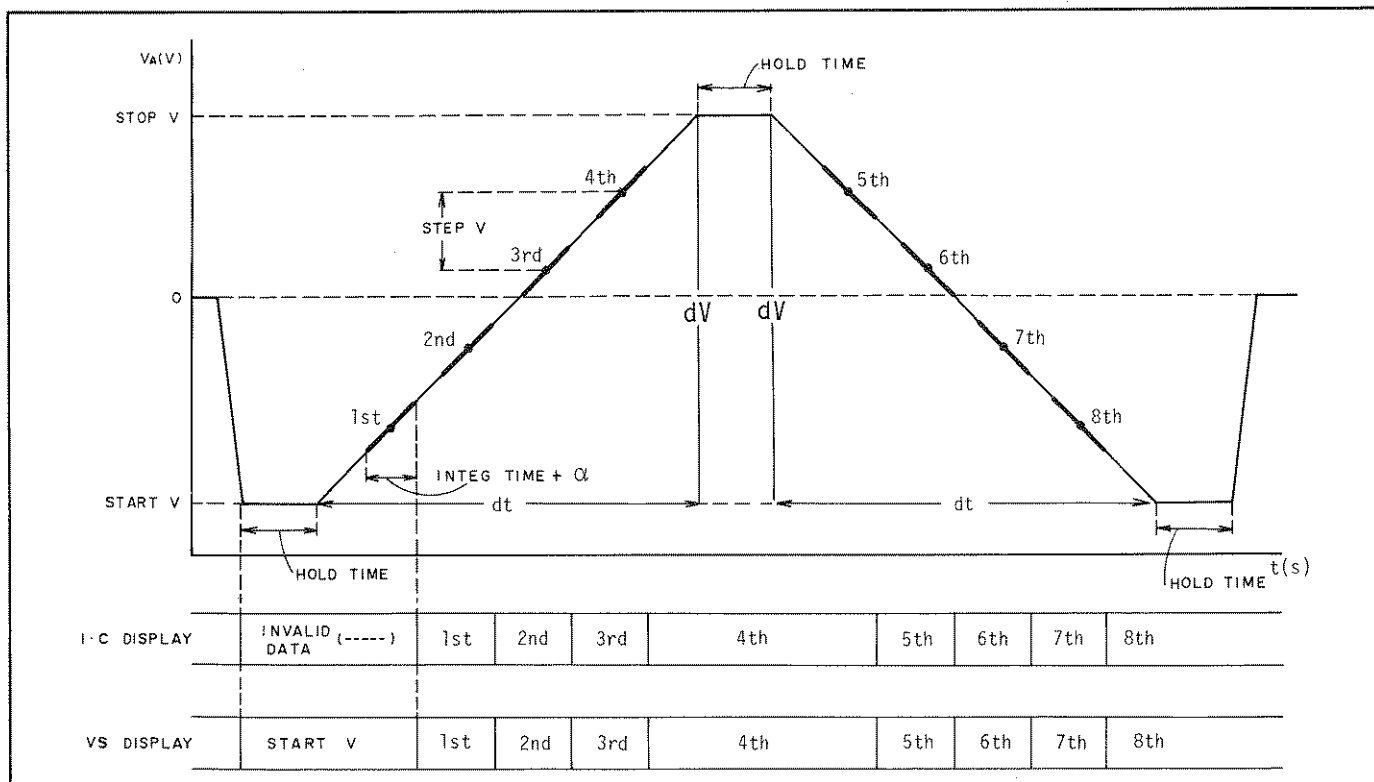
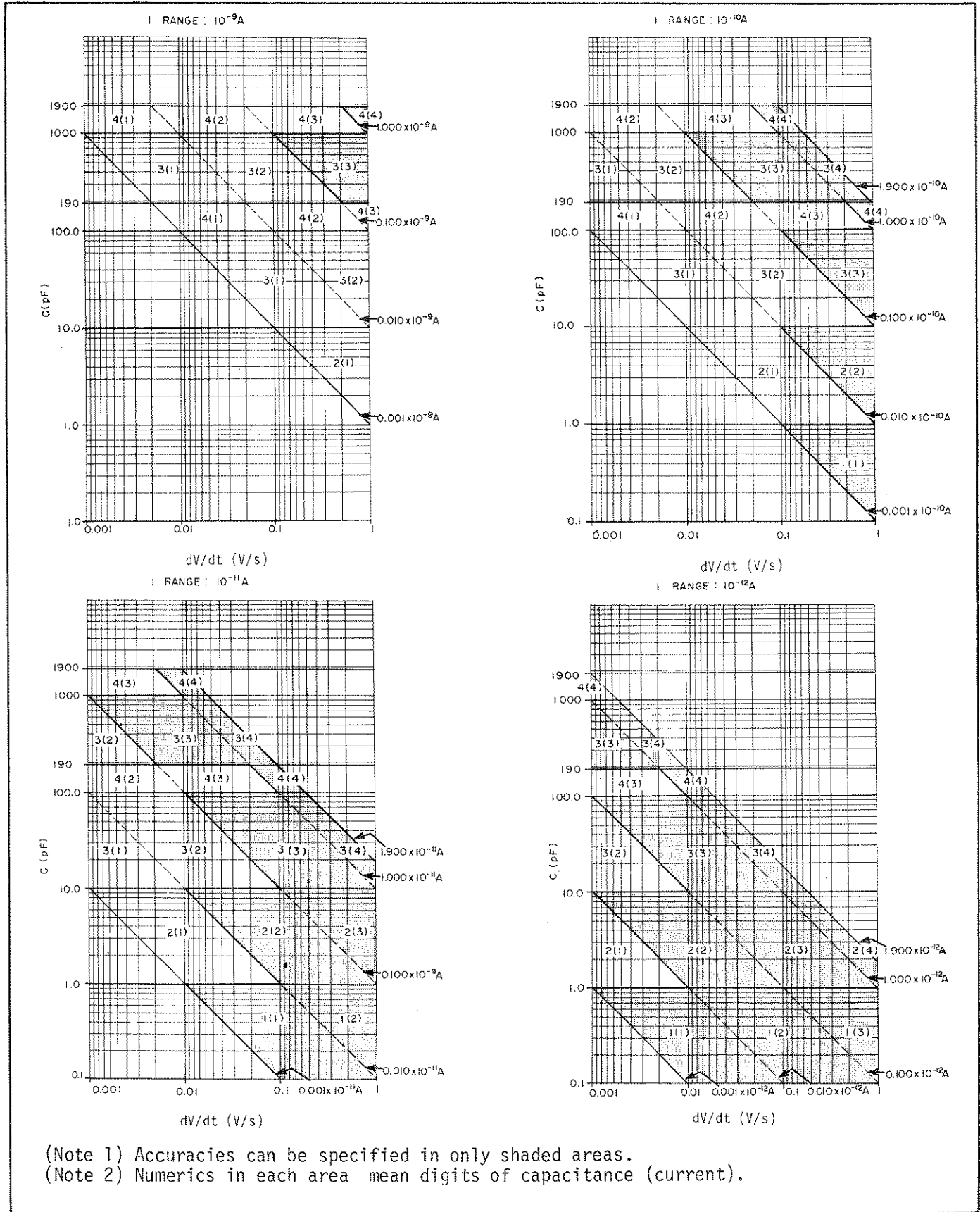

Figure 3-19. Relationship between C-V Measurement and Displays for \wedge (Double Ramp Wave).



(Note 1) Accuracies can be specified in only shaded areas.
 (Note 2) Numerics in each area mean digits of capacitance (current).

Figure 3-20. Relationship between Calculated Capacitance Value and Current Measurement Range.

- (7) Set FUNCTION to C-V.
- (8) At this time, the 4140A panel control functions are automatically set as follows (refer to paragraph 3-8):

VA /
 C measurement
 unit indicator pF

- (9) If calculated capacitance value is to be displayed in percent, set displayed value of I·C DISPLAY to percent change with Percent key.
- (10) Select desired VA output mode with VA Mode Select Key.
- (11) Start C-V measurement with AUTO START key.

Note

These procedures are the most effective methods for setting up the most suitable current measurement range for C-V measurement. However, this method may take a relatively long time when the ramp rate (dV/dt) is set to a slow value. If the approximate capacitance value of DUT is known, the most suitable current range for a C-V measurement can be selected by using Figure 3-21.

The accuracy of the 4140A C-V measurement is determined by the accuracies of the pA Meter current measurement and of the ramp rate (dV/dt) accuracy of the ramp wave (from the above equation). Calculated accuracies for C-V measurements are given in Table 3-6 and Figure 3-22 as reference data (not as specifications).

3-55. C-V Measurement Zero Offset

3-56. In a C-V measurement, the 4140A has a zero offset function for capacitance which is independent of the zero offset function for a current measurement (refer to paragraph 3-23). To reduce the measurement error to minimum, the zero offset for C-V measurement can be used to cancel the offset error of undesired test leads/test fixture stray capacitances. The method for doing a zero offset is described in Figure 3-23. Offset limit for a C-V measurement is 0.0~100.0 pF. The zero offset value is set to 0 pF when the 4140A is turned to ON. When the ZERO offset key is pushed, the value of the I·C DISPLAY adds to the zero offset value.

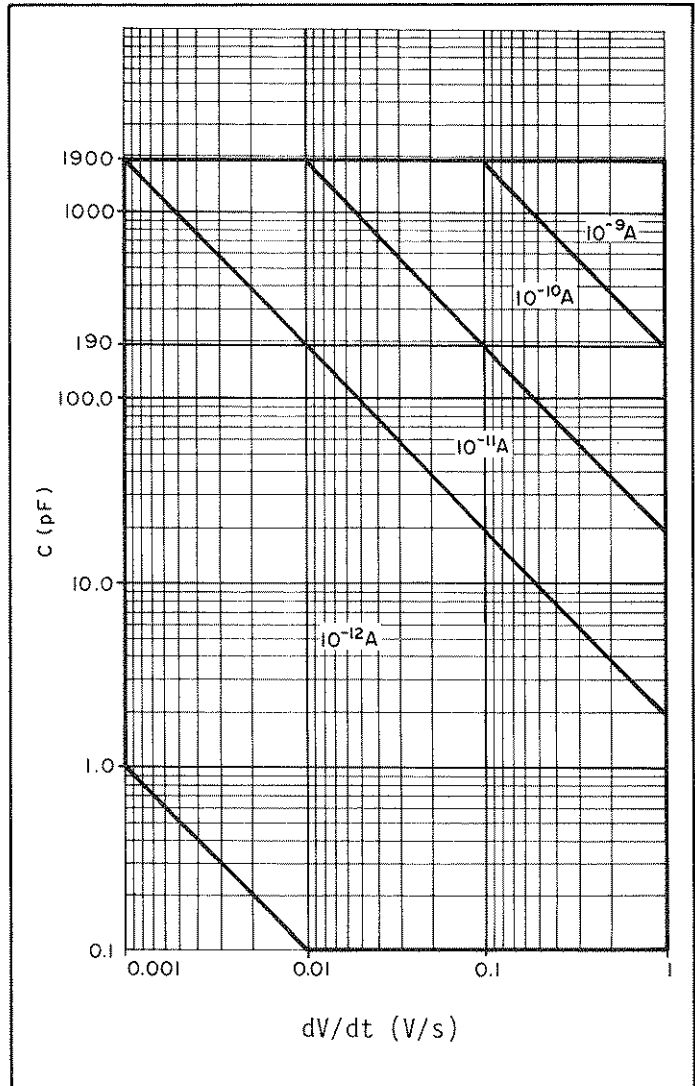

Figure 3-21. Suitable Current Measurement Ranges for C-V Measurements.

Note

With Option 101 HP-IB Interface, a zero offset can also be done by remote program code "Z" via the HP-IB.

Table 3-6. C-V Measurement Accuracy.

| Output Voltage Range (V) | Capacitance Measurement Range (pF) | Current Measurement Range (A) | dV/dt (V/s) | | |
|--------------------------|------------------------------------|-------------------------------|--|------------|--|
| | | | 0.001 ~ 0.01 | 0.01 ~ 0.1 | 0.1 ~ 1 |
| = 10 | 100.0 | 10 ⁻¹⁰ | | | $\pm((2.2 + \frac{0.001}{dV/dt}) + \frac{2}{dV/dt})$ |
| | | 10 ⁻¹¹ | $\pm((5.2 + \frac{0.001}{dV/dt}) + \frac{0.3}{dV/dt})$ | | |
| | | 10 ⁻¹² | $\pm((5.2 + \frac{0.001}{dV/dt}) + \frac{0.08}{dV/dt})$ | | |
| | 1000 | 10 ⁻⁹ | | | $\pm((0.7 + \frac{0.001}{dV/dt}) + \frac{2}{dV/dt})$ |
| | | 10 ⁻¹⁰ | $\pm((2.2 + \frac{0.001}{dV/dt}) + \frac{0.2}{dV/dt})$ | | |
| | | 10 ⁻¹¹ | $\pm((5.2 + \frac{0.001}{dV/dt}) + \frac{0.03}{dV/dt})$ | | |
| | | 10 ⁻¹² | $\pm((5.2 + \frac{0.001}{dV/dt}) + \frac{0.008}{dV/dt})$ | | |
| = 100 | 100.0 | 10 ⁻¹⁰ | | | $\pm((2.2 + \frac{0.008}{dV/dt}) + \frac{2}{dV/dt})$ |
| | | 10 ⁻¹¹ | $\pm((5.2 + \frac{0.008}{dV/dt}) + \frac{0.3}{dV/dt})$ | | |
| | | 10 ⁻¹² | $\pm((5.2 + \frac{0.008}{dV/dt}) + \frac{0.08}{dV/dt})$ | | |
| | 1000 | 10 ⁻⁹ | | | $\pm((0.7 + \frac{0.008}{dV/dt}) + \frac{2}{dV/dt})$ |
| | | 10 ⁻¹⁰ | $\pm((2.2 + \frac{0.008}{dV/dt}) + \frac{0.2}{dV/dt})$ | | |
| | | 10 ⁻¹¹ | $\pm((5.2 + \frac{0.008}{dV/dt}) + \frac{0.03}{dV/dt})$ | | |
| | | 10 ⁻¹² | $\pm((5.2 + \frac{0.008}{dV/dt}) + \frac{0.008}{dV/dt})$ | | |

Note 1. = (% of reading + counts) at 23°C±5°C, ≤ 70% humidity.
 Note 2. Accuracies can be specified only in shaded areas of Figure 3-20.
 Note 3. Leakage current through resistance of DUT and test leads contributes additional error.

3-57. C-V Measurement in Percent

Note

3-58. The C-V measurement of the 4140A can be displayed as percent change VS Cox (the reference capacitance value). Display range in percent is 0.0%~189.9% in 0.1% steps. Cox is the capacitance of an oxide film of MIS construction. Percent change VS Cox is the most suitable display method for normalizing and analyzing C-V characteristics of MIS construction. The Setting limit for Cox is 0.1 pF~189.9pF in 0.1pF steps and 190pF~1900pF in 1pF steps.

If setting of Cox value exceeds the setting limit described above, the VS DISPLAY displays an annunciation (~~U-F~~) and the Cox value selected is not inputted.

3-59. C-V Measurement Operating Instructions.

3-60. Operating instructions for a C-V measurement are given in Figure 3-23.

Note

With Option 101 HP-IB Interface, the Cox value can be set via the HP-IB (refer to paragraph 3-83).

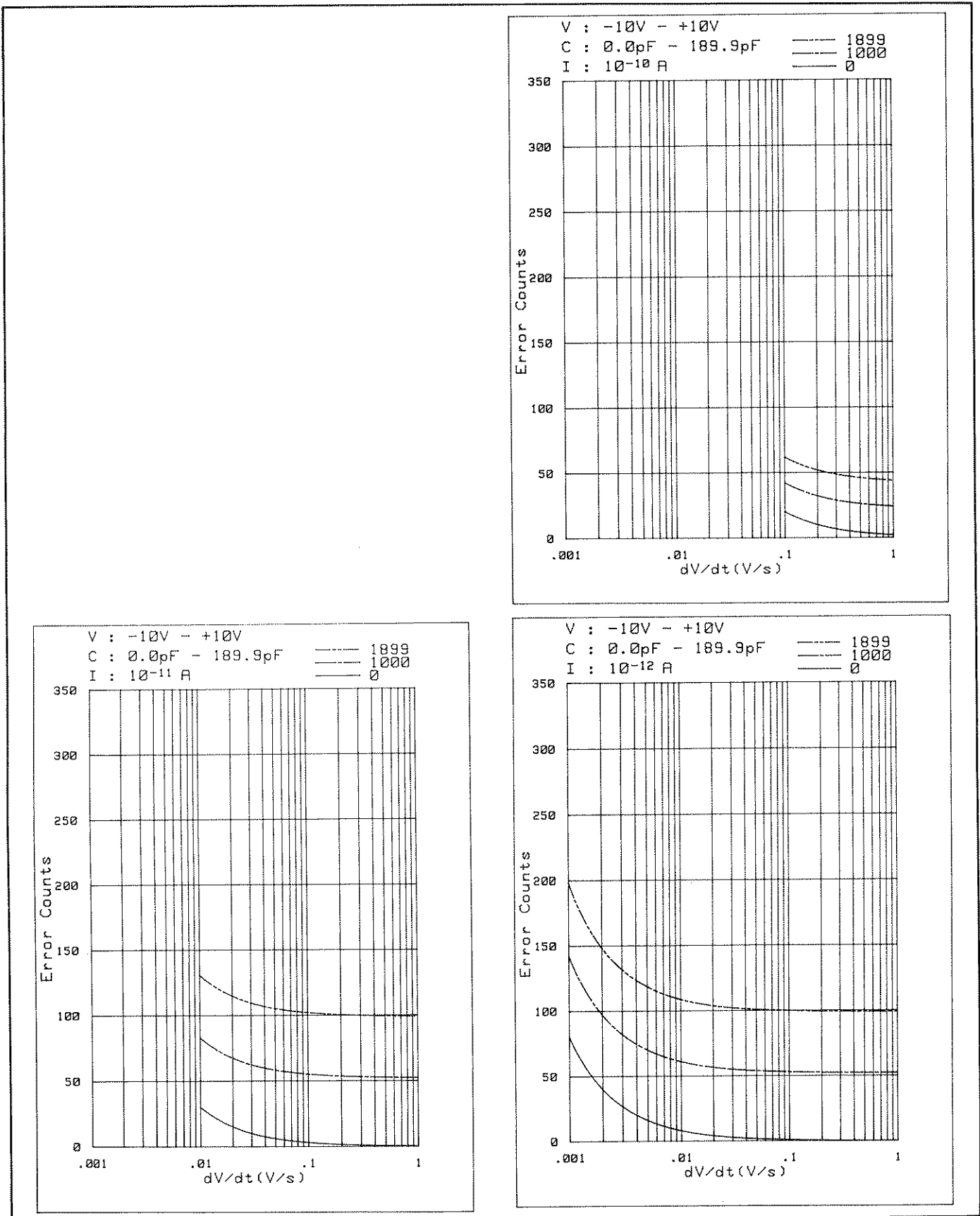

Figure 3-22. C-V Measurement Accuracy (Sheet 1 of 4).

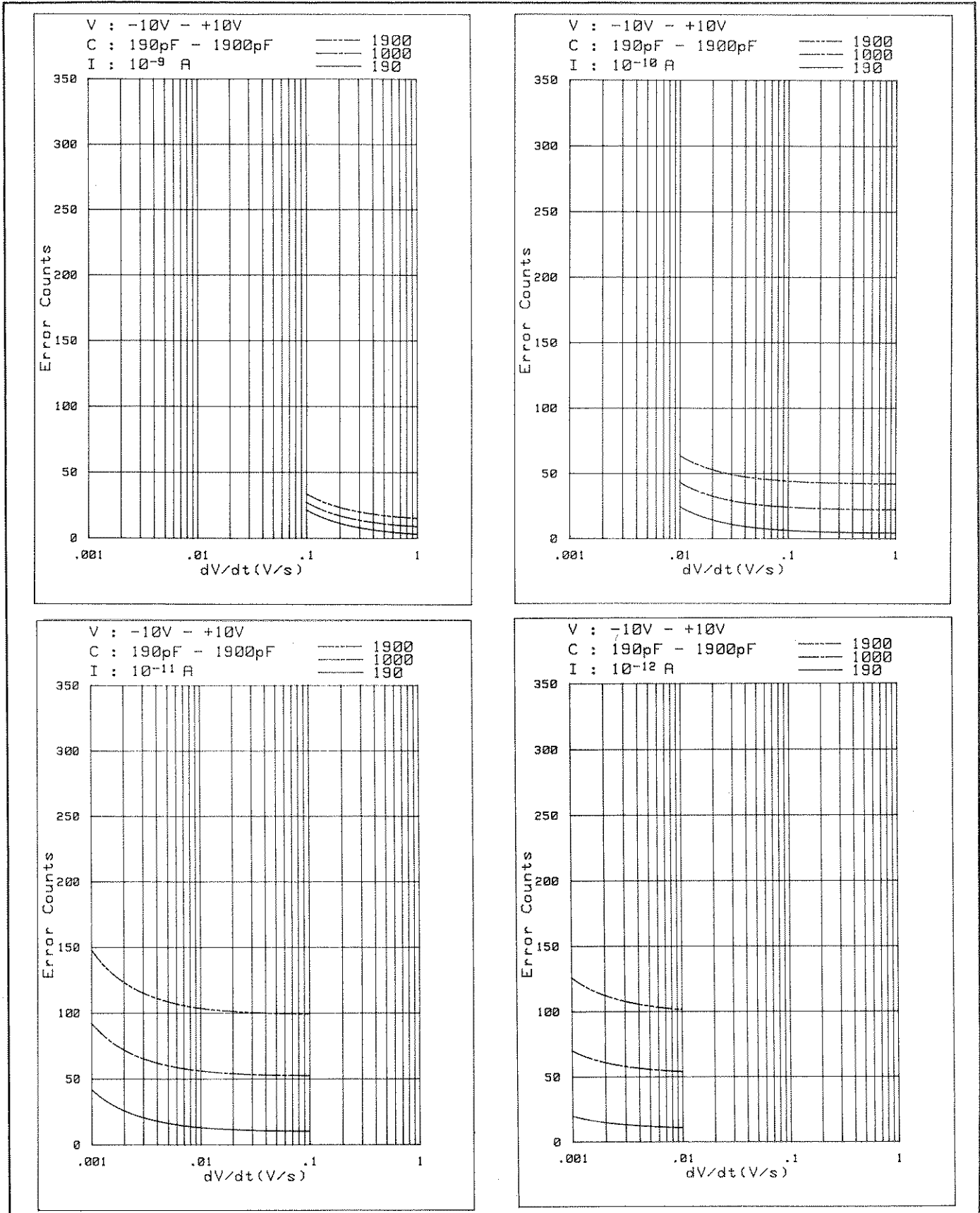

Figure 3-22. C-V Measurement Accuracy (Sheet 2 of 4).

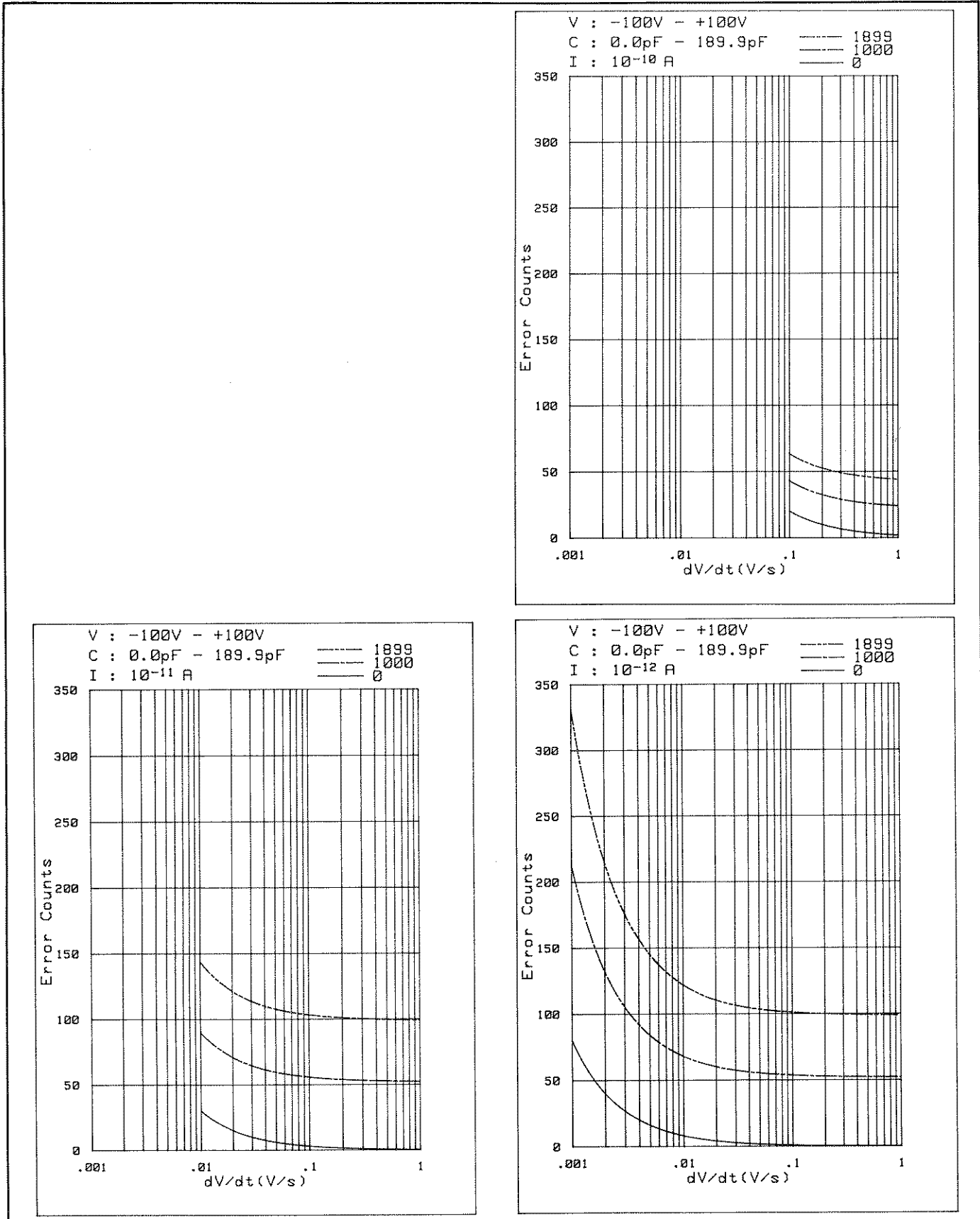

Figure 3-22. C-V Measurement Accuracy (Sheet 3 of 4).

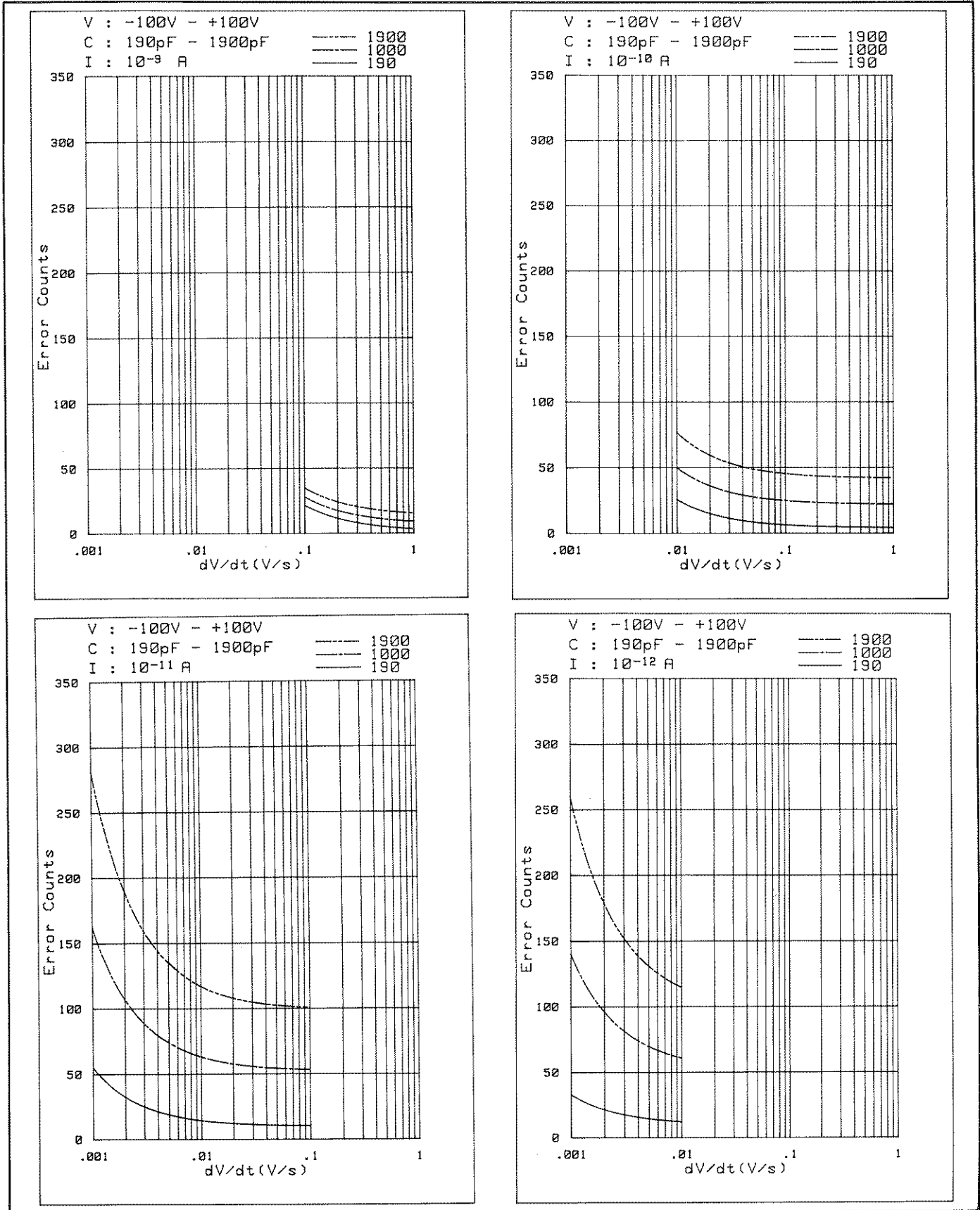
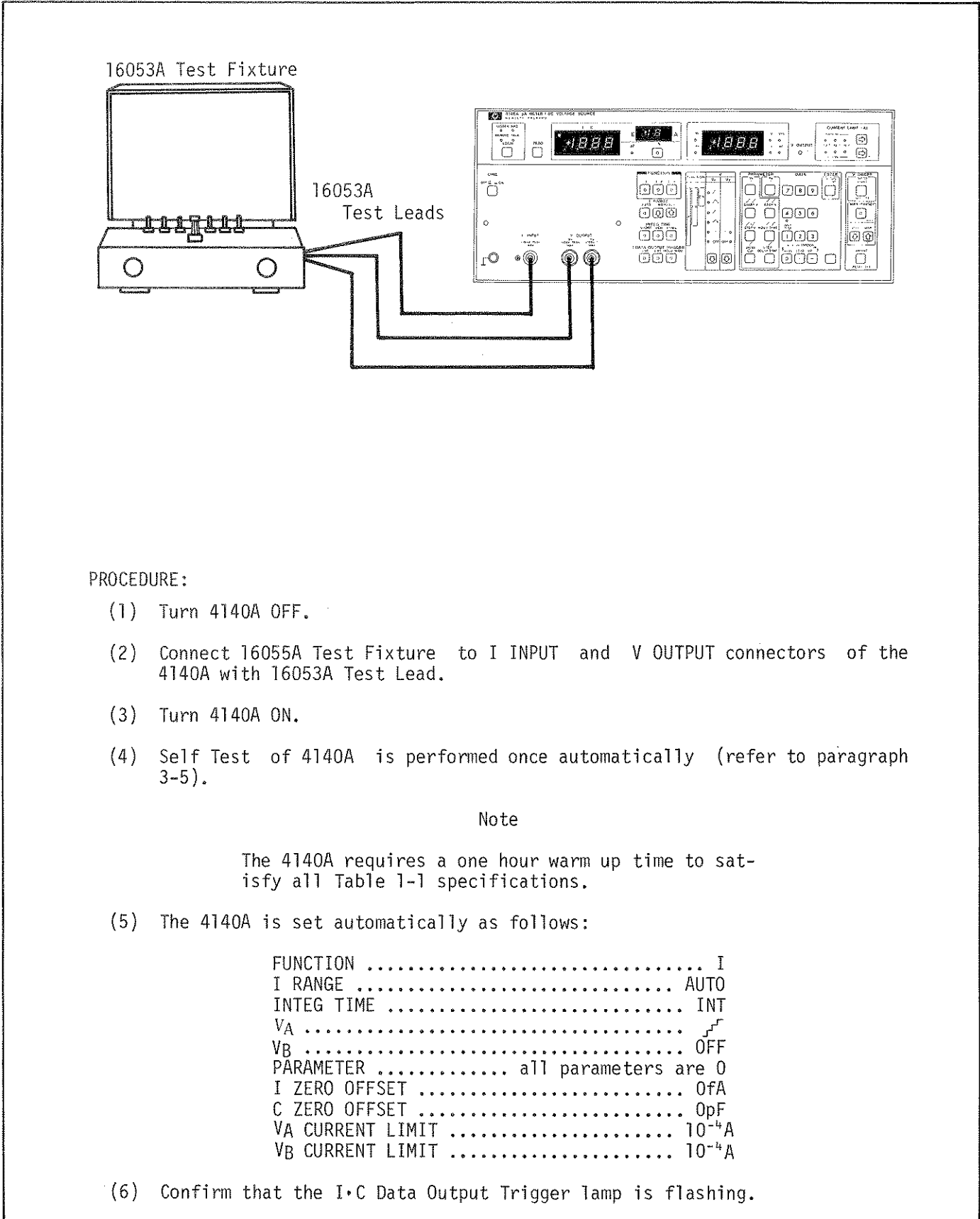

Figure 3-22. C-V Measurement Accuracy (Sheet 4 of 4).



PROCEDURE:

- (1) Turn 4140A OFF.
- (2) Connect 16055A Test Fixture to I INPUT and V OUTPUT connectors of the 4140A with 16053A Test Lead.
- (3) Turn 4140A ON.
- (4) Self Test of 4140A is performed once automatically (refer to paragraph 3-5).

Note

The 4140A requires a one hour warm up time to satisfy all Table 1-1 specifications.

- (5) The 4140A is set automatically as follows:

```

FUNCTION ..... I
I RANGE ..... AUTO
INTEG TIME ..... INT
VA ..... 
VB ..... OFF
PARAMETER ..... all parameters are 0
I ZERO OFFSET ..... 0fA
C ZERO OFFSET ..... 0pF
VA CURRENT LIMIT ..... 10-4A
VB CURRENT LIMIT ..... 10-4A
    
```

- (6) Confirm that the I·C Data Output Trigger lamp is flashing.

Figure 3-23. C-V Function Operating Instructions (sheet 1 of 3).

- (7) Select desired current measurement range with I RANGE keys (refer to paragraph 3-53).
- (8) Select desired integration time with the INTEG TIME keys (refer to paragraph 3-18).
- (9) Set FUNCTION to C-V.
- (10) VA output mode is automatically set to \int .
- (11) Select desired VA and VB output modes with VS Mode Select keys (refer to paragraph 3-31).
- (12) Input values for VA operating parameters (START V, STOP V, STEP V, HOLD TIME and dV/dt) (refer to paragraph 3-33).
- (13) When calculated capacitance value is to be displayed in percent, input value for Cox (refer to paragraph 3-57).
- (14) If VB is to be used, input value for VB = .
- (15) Select current limit values of VA and VB with CURRENT LIMIT Select keys (refer to paragraph 3-39).
- (16) Select low lead connection of pA Meter section in the 4140A with 16055A LOW LEAD CONNECTION Select switch (depending on kind of measurement).
- (17) Connect nothing to 16055A (Open).
- (18) Start C-V measurement with AUTO START key on front panel.
- (19) Set I·C DISPLAY to 0.0pF with ZERO offset key (refer to paragraph 3-55).

Note

Any residual capacitance which exists on test leads or test fixture increases the error of the C-V measurement. To avoid this condition, do a ZERO offset under the same conditions as for an actual measurement.

- (20) When calculated capacitance value is to be displayed in percent, set displayed value of I·C DISPLAY to percent change with percent key.
- (21) Connect DUT to 16055A with alligator clips or T0-5 socket depending on kind of measurement.
- (22) Start C-V measurement with AUTO START key.

Figure 3-23. C-V Function Operating Instructions (sheet 2 of 3).

Connection for Quasi-Static C-V characteristic measurement are given below:

MOS Diode:

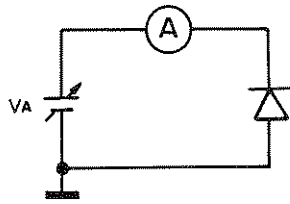

Figure 3-23. C-V Function Operating Instructions (sheet 3 of 3).

3-61. ANNUNCIATIONS

3-62. If control keys parameters are set incorrectly or when the measured current value exceeds the upper range limit, the 4140A displays one of the annunciators given in Table 3-7. If one of these annunciators is displayed, follow the correction procedures described in Table 3-7. In addition, if one of the DC voltage sources, VA or VB, exceeds its current limit, its CURRENT LIMIT lamp will flash.

Table 3-7. 4140A Annunciators (Sheet 1 of 2).

| ① I-C DISPLAY Annunciators | | |
|----------------------------|---|--|
| Annunciators | Indicated Condition and Control Settings | CORRECTION PROCEDURE |
| O-F | <p>Indicated Condition: Measured current value exceeds upper range limit.</p> <p>Control Settings:</p> <p>(1) FUNCTION ... I or I-V I RANGE MANUAL</p> <p>(2) FUNCTION C-V I RANGE MANUAL</p> <p>(3) I RANGE AUTO</p> | <p>(1-1) Sets I RANGE to AUTO.</p> <p>(1-2) If a range "poll" is being done, set maximum range for auto range measurement as in step (1-1) above.</p> <p>(2-1) Sets I RANGE to AUTO.</p> <p>(2-2) If a range "hold" measurement is being done, refer to paragraph 3-53.</p> <p>(3-1) Change measurement condition.</p> |
| COF | <p>Indicated Condition: Calculated capacitance value exceeds the upper limit (1900pF).</p> | Change measurement condition (ex.set dV/dt to lower value). |
| POF | <p>Indicated Condition: Calculated capacitance value in percent exceeds its upper limit (199.9%).</p> | Change Cox to greater value. |

Table 3-7. 4140A Annunciations (Sheet 1 of 2).

| ② VS DISPLAY Annunciations | | |
|----------------------------|--|---|
| Annunciations | Indicated Condition | Correction Procedure |
| 0-F | Setting parameter value exceeds its upper limit. | Reset parameter value. Refer to Table 3-4. |
| ILLE | VA is swept when parameters are set incorrectly. | Reset parameter values. Refer to Table 3-4. |

3-63. OPTION OPERATION

3-64. Operating instructions for Option 001 Analog Output and Option 101 HP-IB Interface are described in the following paragraphs. However, option installation information is provided in Section II.

3-65. OPTION 001 ANALOG OUTPUT

3-66. The 4140A Option 001 Analog Output can be used to output analog data of the pA Meter and DC Voltage Source as given in Tables 3-8 and 3-9. When a 4140A equipped Option 001 is connected to an X-Y Recorder (e.g. HP Model 7047A), the system can be used to trace I-V/C-V curves. The procedures for using the 4140A with Option 001 and an X-Y Recorder are given in Figure 3-24.

3-67. Control Capabilities for Option 001 Analog Output.

3-68. The 4140A with Option 001 Analog Output has three capabilities for more easily, quickly and clearly tracing I-V/C-V curves. These capabilities are:

- (1) Control of pen position of the X-Y Recorder.

With control keys LL, ZERO and UR, a 4140A with Option 001 is able to control the X-Y recorder pen position as in Table 3-10.

Note

With Option 101, control of the pen position can be done by remote control via the HP-IB. Refer to paragraphs 3-69 thru 3-98 for more specific information on the HP-IB.

- (2) Control signals for X-Y Recorder pen-lift TTL controls.

When the X-Y Recorder is provided with pen lift TTL controls, pen lift can be done automatically by outputted TTL signals from the PEN LIFT connector on rear of the 4140A. Outputted TTL signal is set to High (PEN UP) when V OUTPUT lamp is lit, and set to Low (PEN DOWN) when V OUTPUT lamp is not lit.

Table 3-8. Analog Output Data at I/C OUTPUT Connector.

| Function | Value of I·C DISPLAY | Analog Output Data (V) | Resolution |
|----------|----------------------|------------------------|-------------|
| I | 0 ~ ±1900 | 0.000 ~ ±9.500 | 5mV/count |
| C | 0.0 ~ 190.0 | 0.0000 ~ 0.9500 | 500µV/count |
| | 191 ~ 1900 | 0.955 ~ 9.500 | 5mV/count |
| % | 0.0 ~ 199.9 | 0.000 ~ 9.995 | 5mV/count |

Table 3-9. Analog Output Data at VA OUTPUT Connector.

| Outputted VA Voltage (V) | Analog Output Data (V) | Resolution |
|--------------------------|------------------------|------------|
| 0.00 ~ ±10.00 | 0.000 ~ ±1.000 | 1mV/count |
| ±10.1 ~ ±100.0 | ±1.01 ~ ±10.00 | 10mV/count |

(3) Low-pass filter for reducing noise on Analog Output data.

If the outputted analog data includes considerable noise and the I-V/C-V curves are strong curves, the low-pass filters provided in the Option 001 Analog Output

circuitry, can be used to reduce the noise. I-V/C-V curves are traced more smoothly. The filters apply to both V_A and I/C OUTPUT data. Filter rise time can be changed with FILTER TIME CONST select switch on rear panel of 4140A.

Table 3-10. X-Y Recorder Pen Position Control.

| Key | Outputted Voltage from V_A OUTPUT Connector | Outputted Voltage from I/C OUTPUT Connector |
|---------------------|---|---|
| UR (Upper Right) | Greater voltage (START V or STOP V). | Voltage at plus full scale of I.C DISPLAY (+5V). |
| LL (Lower Left) | Lesser voltage (START V or STOP V). | I-V: -5V (Voltage at minus full scale). C-V: 0V. |
| ZERO | 0V. | 0V. |

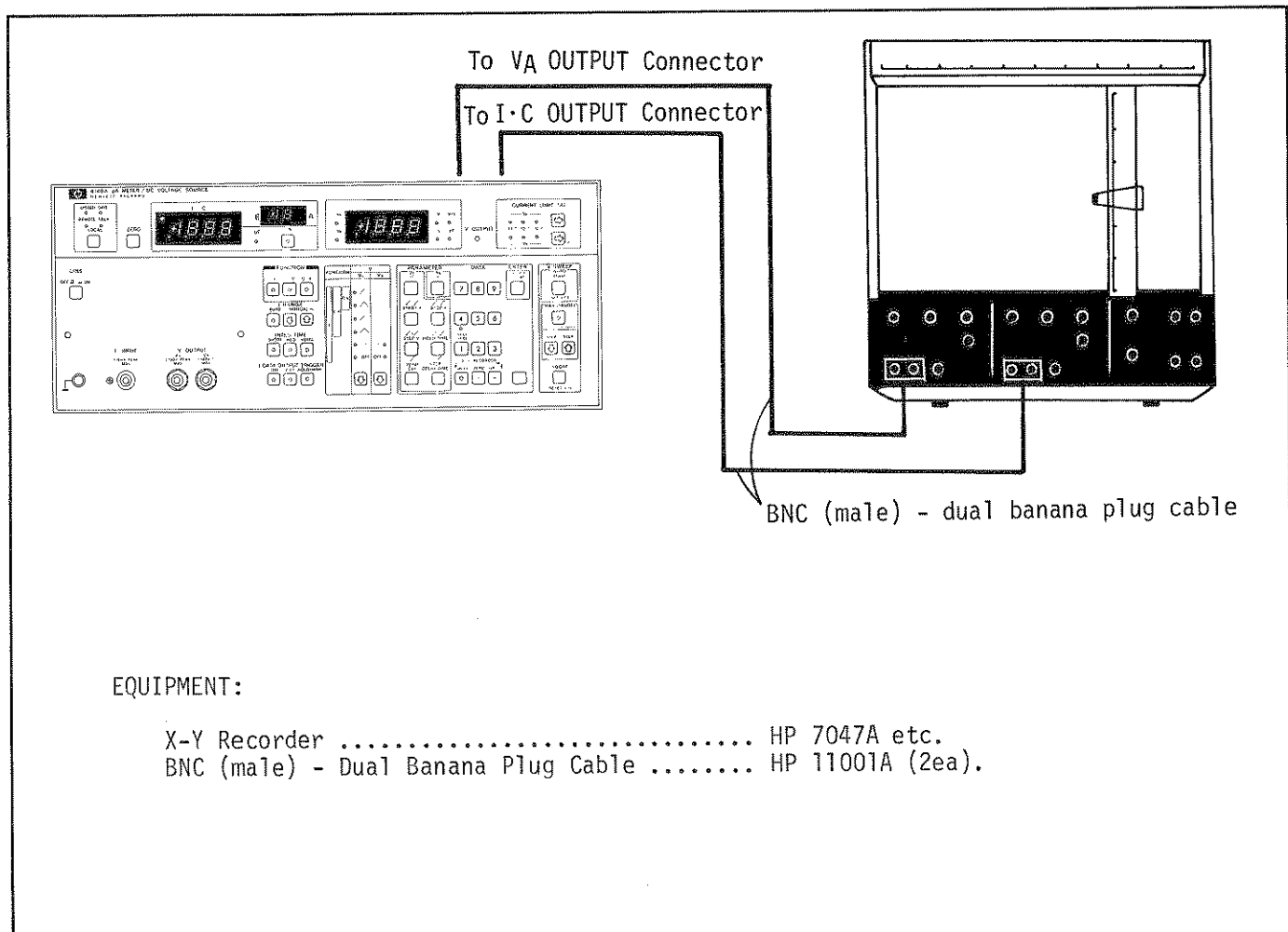

Figure 3-24. Option 001 Analog Output Operating Instructions (sheet 1 of 2).

PROCEDURE:

- (1) Turn 4140A and X-Y Recorder OFF.
- (2) Connect I/C OUTPUT connector on rear panel of 4140A to Y axis input terminals of X-Y Recorder and VA OUTPUT connector to X axis input terminals with BNC (male) - dual banana plug cables.
- (3) When X-Y Recorder is provided pen lift TTL controls, connect PEN LIFT connector on rear panel of 4140A to X-Y Recorder connector.
- (4) Connect test leads or fixture (ex. 16053A Test Lead) to 4140A.
- (5) Turn 4140A and X-Y Recorder ON.
- (6) Set front panel controls and parameters. Refer to Figure 3-17 for I-V measurement or Figure 3-23 for C-V measurement.

Note

The 4140A HOLD TIME parameter should be set after considering the relationship between the pen position as the 4140A starts its sweep measurement and the slewing speed/accleration of the X-Y Recorder.

- (7) Place chart paper on recording platen.
- (8) Install disposable pen in X-Y Recorder.
- (9) Adjust zero position of X-Y Recorder.

Note

The outputted voltages from VA and I/C OUTPUT connectors are set to 0V by the ZERO key on 4140A front panel.

- (10) Set input ranges of X and Y axis for X-Y Recorder.

Note

When setting input ranges, check amplitude of I-V or C-V curve by using control keys, LL (Lower Left) and UR (Upper Right).

- (11) Connect DUT to test leads or mounting fixture connected to 4140A.
- (12) Lower X-Y Recorder pen onto chart paper. If X-Y Recorder is provided with pen lift TTL controls, pen is lowered automatically when sweep measurement is started (when V OUTPUT lamp is lit).
- (13) Start 4140A I-V or C-V measurement and do X-Y Recorder trace of I-V or C-V curve.
- (14) Lift X-Y Recorder pen from the chart paper when measurement is complete and X-Y Recorder stops. If X-Y Recorder is provided pen lift TTL controls, pen is raised automatically when measurement is complete (when V OUTPUT lamp is extinguished).

Figure 3-24. Option 001 Analog Output Operating Instructions (sheet 2 of 2).

3-69. OPTION 101 HP-IB INTERFACE.

3-70. The Model 4140A Opt. 101 can be remotely controlled by means of the HP-IB which is a carefully defined instrumentation interfacing method that simplifies the integration of instruments and a calculator, or computer, into a system.

Note

HP-IB is Hewlett-Packard's implementation of IEEE Std. 488-1975 Standard Digital Interface for Programmable Instrumentation.

3-71. Connection to HP-IB.

3-72. A 4140A equipped with Opt. 101 may be connected into an HP-IB bus configuration with or without a controller (e.g. with or without an HP calculator). In an HP-IB system without a controller, the 4140A Opt. 101 can function as a Talk Only unit (refer to paragraph 3-77).

3-73. HP-IB Status Indicators.

3-74. The HP-IB Status Indicators are four LED lamps on the front panel. These lamps show the status of the 4140A in an HP-IB system as follows:

- SRQ: SRQ signal on HP-IB line from 4140A (refer to paragraph 3-93).
- LISTEN: The 4140A is set to be listener.
- TALK: The 4140A is set to be talker.
- REMOTE: The 4140A is remotely controlled.

3-75. LOCAL Key.

3-76. The LOCAL key disables remote control from HP-IB control and enables setting measurement conditions at front panel controls (pushbutton keys). REMOTE HP-IB status indicator lamp turns off when LOCAL key is depressed. This function can not be used when the 4140A is set to local lockout status by controller.

3-77. HP-IB Control Switch.

3-78. The HP-IB Control Switch on the rear panel controls seven digits and three capabilities as follows:

- (1) Bit 1~5: The HP-IB address is established by these five digits of the control switch.

- (2) Bit 6 (delimiter form bit): This bit determines delimiter forms of output data which are:

- 0: Format A (comma).
- 1: Format B (carriage return, line feed).

- (3) Bit 7 (talk only bit): This bit determines instrument capabilities which are:

- 0: Addressable
- 1: Talk Only

Note

The 4140A Opt. 101 is set at the factory as given in Figure 3-25.

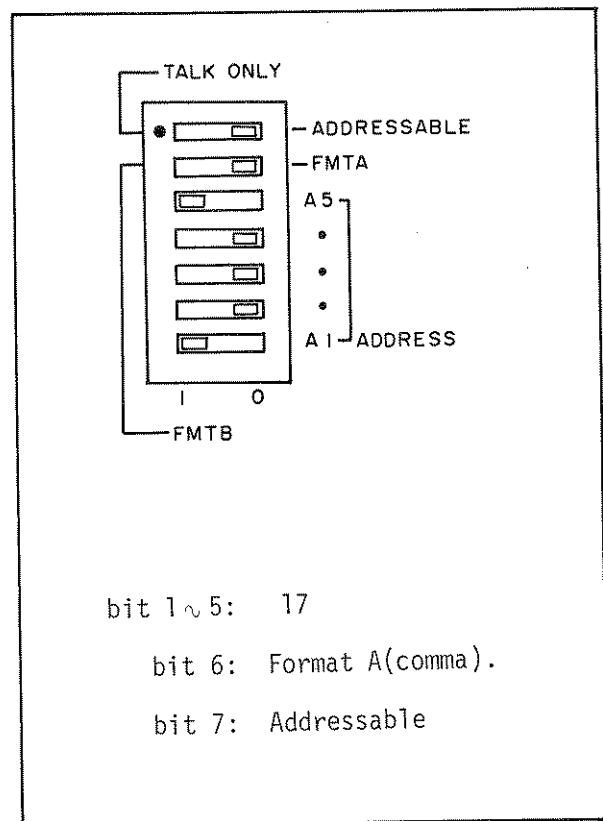

Figure 3-25. HP-IB Control Switch.

3-79. HP-IB Interface Capabilities of 4140A Opt. 101.

3-80. The interface of a device connected to the HP-IB is specified by the interface functions built into the device. The 4140A Opt. 101 has eight HP-IB interface functions as given in Table 3-11.

3-81. Remote Program Code.

3-82. Remote program codes for the 4140A Opt. 101 are listed in Table 3-12.

Table 3-11. HP-IB Interface Capabilities.

| Code | Interface Function* (HP-IB Capabilities) |
|---|---|
| SH1** | Source Handshake. |
| AH1 | Acceptor Handshake. |
| T5 | Talker (basic talker, serial poll, talk only mode, unaddress to talk if addressed to listen). |
| L4 | Listener (basic listener, unaddress to listen if addressed to talk). |
| SR1 | Service Request. |
| RL1 | Remote/Local (with local lockout). |
| DC1 | Device Clear. |
| DT1 | Device Trigger. |
| <p>* Interface functions provide the means for a device to receive, process and transmit messages over the bus.</p> <p>** The suffix number of the interface code indicates the limitation of the function capability as defined in Appendix C of IEEE Std. 488-1975.</p> | |

Table 3-12. Remote Program Code (sheet 1 of 3).

| FUNCTION | Control | Program Code | Description |
|----------|-------------------|--------------|--|
| FUNCTION | I | F1* | Description of HSI (high speed I function) is provided in paragraph 3-95. |
| | I-V | F2 | |
| | C-V | F3 | |
| | HSI | F4 | |
| RANGE | HOLD | RA0 | When FUNCTION is set to F1 (I), F2 (I-V or F4 (HSI), RAI is automatically set. |
| | AUTO | RA1* | |
| | 10 ⁻² | R02 | |
| | 10 ⁻³ | R03 | |
| | 10 ⁻⁴ | R04 | |
| | 10 ⁻⁵ | R05 | |
| | 10 ⁻⁶ | R06 | |
| | 10 ⁻⁷ | R07 | |
| | 10 ⁻⁸ | R08 | |
| | 10 ⁻⁹ | R09 | |
| | 10 ⁻¹⁰ | R10 | |

Table 3-12. Remote Program Code (sheet 2 of 3).











| | Control | Program Code | Description |
|------------------|---|--------------|---|
| | 10 ⁻¹¹ | R11 | |
| | 10 ⁻¹² | R12 | |
| INTEGRATION TIME | SHORT | I1 | |
| | MEDIUM | I2 | |
| | LONG | I3* | |
| I TRIGGER MODE | INT | T1* | These codes are used only to set and not for triggering. When FUNCTION is set to F1 (I) or F4 (HSI), T1 is automatically set. |
| | EXT | T2 | |
| | HOLD/MAN | T3 | |
| C% Enable | pF | C0 | When FUNCTION is set to F3 (C-V), C0 is automatically set. |
| | % | C1 | |
| SWEEP CONTROL |  | W1 | W4 is used when 4140A is set to AUTO SWEEP Mode. W2, W5 and W6 are used when 4140A is set to MANUAL SWEEP Mode. |
| | MANUAL | W2 | |
| | PAUSE | W3 | |
| | RESTART | W4 | |
| |  | W5 | |
| |  | W6 | |
| |  | W7 | |
| VA MODE |  | A1 | When FUNCTION is set to F1 (I), F2 (I-V) or F4 (HSI), A3 is automatically set. |
| |  | A2 | |
| |  | A3* | When FUNCTION is set to F3 (C-V), A1 is automatically set. |
| |  | A4 | |
| |  | A5 | |
| | OFF | A6 | |
| VB MODE |  | B1 | |
| | OFF | B2* | |
| VA I LIMIT | 100µA | L1* | |
| | 1mA | L2 | |
| | 10mA | L3 | |

Table 3-12. Remote Program Code (sheet 3 of 3).

| | Control | Program Code | Description |
|------------|-----------|--------------|--|
| VB I LIMIT | 100µA | M1* | |
| | 1mA | M2 | |
| | 10mA | M3 | |
| ZERO SET | | Z | |
| SELF TEST | OFF | S0* | |
| | ON | S1 | |
| SRQ MASK | OFF | D0* | These program codes are used to control bits 1 thru 3 of SRQ Status Byte as follows: Bit 1: DATA READY Bit 2: CURRENT LIMITER Bit 3: AUTO SWEEP or SELF TEST END Refer to Figure 3-26. for more specific information on SRQ Status Byte. |
| | ON (1) | D1 | |
| | ON (2) | D2 | |
| | ON (1, 2) | D3 | |
| | ON (3) | D4 | |
| | ON (1, 3) | D5 | |
| | ON (2, 3) | D6 | |
| ON (All) | D7 | | |
| TRIGGER | | E | |
| KEY STATUS | | K | |
| RECORDER | LL | XL | |
| | ZERO | XZ | |
| | UR | XR | |

* : power ON

3-83. Parameter Setting

3-84. A 4140A Opt. 101 can be set to nine parameters (refer to Table 3-13) by remote programming as follows:

$\underline{XX \pm NNNN.NNX}$ \textcircled{CR} \textcircled{LF}
 (1) (2) (3) (4)

- (1) Program Code for Parameter Setting (refer to Table 3-13).
- (2) Setting Value (numeric or space).
- (3) Delimiter: ; (semi-colon)
 , (comma)
 N
- (4) Terminator

3-85. Data Output

3-86. Data outputted by the Model 4140A Opt. 101 consists of:

- (1) I-C Measurement Value and V_A Output Voltage.
- (2) Setting Parameter Output.
- (3) Key Status.
- (4) Service Request Status Byte.

In the following several paragraphs, each output data form is described.

Table 3-13. Program Code for Parameter Setting.

| Parameter | Program Code | Setting Value |
|---------------------|--------------|----------------------------------|
| $V_A \equiv (V)$ | PA | -10.00 ~ 10.00 -100.0 ~ 100.0 |
| START V (V) | PS | -10.00 ~ 10.00 -100.0 ~ 100.0 |
| STOP V (V) | PT | -10.00 ~ 10.00 -100.0 ~ 100.0 |
| STEP V (V) | PE | -10.00 ~ 10.00 |
| HOLD/TIME (s) | PH | 0.1 ~ 1999 |
| dV/dt (V/s) | PV | -1.000 ~ 1.000 |
| Cox (pF) | PC | 0.1 ~ 1999 |
| STEP DELAY TIME (s) | PD | 0.01 ~ 100.0 |
| $V_B \equiv (V)$ | PB | -10.00 ~ 10.00 -100.0 ~ 100.0 |

3-87. I·C Measurement Value and V_A Output Voltage

3-88. Two output formats are possible with the 4140A Opt. 101:

a. Format A

To output either I·C measurement value or V_A output voltage in a continuous string, the delimiter form bit (HP-IB control switch Bit 6) on the rear panel is set to 0 (see paragraph 3-77). In this mode, data is outputted in the following format:

XX±N.NNNE-NN,A±NNN.NN (CR) (LF)
(1)(2)(3) (4) (5)(6) (7) (8)

Note

The 4140A Opt. 101 is set at the factory for output Format A.

b. Format B

To break the data into two groups (limits line length) for outputting to certain peripherals such as to an HP Model 5150A Thermal Printer, the delimiter form bit on rear panel is set to 1 (see paragraph 3-77). All data is then outputted in the following format:

XX±N.NNNE-NN (CR) (LF)
(1)(2)(3) (4) (8)
A±NNN.NN (CR) (LF)
(6) (7) (8)

(1) Space

(2) Data Status

- N ... Normal Data
- O ... Over Flow
- X ... No Data (only measurements using ramp wave)
- L ... Last Data (only in Auto Sweep Mode)

(3) I and C Measurement Functions

- I ... Current Measurement
- C ... Capacitance Measurement (pF Display)
- % ... Capacitance Measurement (%) Display)

(4) Value of I·C Measurement

(5) Comma

(6) Symbol of V_A Output Voltage

(7) Value of V_A Output Voltage

(8) Data Terminator

3-89. Parameter Output

3-90. Nine parameters can be set in the 4140A Opt 101 as given in Table 3-13 (refer to paragraph 3-83). Setting values of parameters can be outputted in the following format by using their program codes (refer to Figure 3-29).

XX±NNNN.NNN; (CR) (LF)
(1)(2) (3) (4) (5)

(1) Space

(2) Program codes for 4140A parameter

(3) Setting value of 4140A parameter

(4) Parameter terminator

(5) Data Terminator

3-91. Key Status Data

3-92. This data is outputted from 4140A when the program code "K" is used (refer to Figure 3-31). The data is outputted in the following format:

FNRNNINTNCNANBNLNMNSNDN (CR) (LF)
(1)(2) (3) (4)(5)(6)(7)(8)(9)(10)(11)(12) (13)

(1) Space

(2) F1 ~ F4: FUNCTION

(3) RAO, RA1, RO2 ~ R12: RANGE

(4) I1 ~ I3: INTEGRATION TIME

(5) T1 ~ T3: I TRIGGER MODE

(6) C0 ~ C1: C% Enable

(7) A1 ~ A6: V_A MODE

(8) B1, B2: V_B MODE

(9) L1 ~ L3: V_A I LIMIT

(10) M1 ~ M3: V_B I LIMIT

(11) S0, S1: SELF TEST

(12) D0, D1: DATA READY

(13) Data Terminator

3-95. High Speed I (HSI) Function.

3-93. Service Request Status Byte.

3-96. The 4140A Option 101 has not only I, I-V and C-V functions but also has a High Speed I (HSI) function. This facilitates high speed data output of the current measurement. This function can be set only by remote program code (F4), and can not be set

3-94. The 4140A Opt. 101 sends RQS (Request Service) signal whenever one of bits 1 thru 4 or 6 is set. Figure 3-26 shows the Status Byte makeup of 4140A.

| Bit | 8 | 7 | 6 | 5 | 4 | 3 | 2 | 1 |
|-------------|---|-----|-----|-----|-----|-----|-----|-----|
| Information | 0 | 0/1 | 0/1 | 0/1 | 0/1 | 0/1 | 0/1 | 0/1 |

Signal bit 7 (RQS signal) establishes whether or not service request exists. Signal bits 1 thru 4 or 6 identify the character of the service request states. Service request states of the 4140A are

- (1) Bit 1: If Data Ready is set to ON, this state is set when measurement data is provided.
- (2) Bit 2: When CURRENT LIMIT is operating (when LED lamp on front panel is lit), this state is set.
- (3) Bit 3: When SELF TEST or Auto-Sweep Measurement is completed, this state is set.

Note

Bits 1 thru 3 are set when SRQ MASK (refer to Table 3-12) is set to ON.

- (4) Bit 4:
 - ① When the 4140A receives an erroneous remote program code, this state is set.
 - ② If the 4140A receives an illegal program when DC Voltage Source is operating (when V OUTPUT lamp on front panel is lit), this state is set.
 - ③ When parameter is set to a value over its setting limit (when VS DISPLAY on front panel displays "O-F"), this state is set.
 - ④ If V_A is swept when parameters are not set correctly (when VS DISPLAY on front panel displays "ILLE"), this state is set.
- (5) Bit 6: If Self Test is faulty, this state is set.

Signal bit 5 is independent of bit 7 (RQS Signal). When DC Voltage Source is operating (when V OUTPUT lamp on front panel is lit), this state is set.

Figure 3-26. Status Bytes of the 4140A.

by front panel controls. When 4140A is set to HSI function, I-C DISPLAY on front panel displays "H-I". The 4140A Option 101 outputs current measurement data via HP-IB as in Figure 3-27 when 4140A is set to HSI function. This output data is the raw current measurement value before it is digitally integrated (refer to paragraph 3-18). This permits an 4140A Option 101 in its HSI function to output data at higher speed than in its general I function. Accuracy and data output intervals for the HSI function are shown in Table 3-14. Sample program for HSI function using a HP Desktop Computer 9825A/9835A is given in Figure 3-32.

Table 3-14. Accuracy and Data Output Interval in HSI Function.

| Range (A) | Accuracy* | Data Output Interval (ms) | |
|------------------------|--------------|---------------------------|------------|
| | | Internal | External |
| $10^{-2} \sim 10^{-9}$ | $\pm(0.5+6)$ | 10(8.3)** | ≥ 2.5 |
| 10^{-10} | $\pm(2+6)$ | | |
| 10^{-11} | $\pm(5+20)$ | | |
| 10^{-12} | $\pm(5+25)$ | | |

* \pm (% of reading + counts) at 23°C \pm 5°C, \leq 70 humidity.
** at 50(60)Hz line frequency.

HSI(HIGH SPEED I) FUNCTION

Program code "F4" for the 4140A Option 101 establishes not only the HSI (High Speed I) function, but also starts data output from 4140A Option 101. When 4140A receives "F4" from controller, the 4140A output is zero. Next, the 4140A Option 101 sends an invalid byte (32 in decimal, space in ASCII) as the first byte. Beginning with the second byte, 4140A current measurement data in binary code is transmitted. Each transmission of current measurement data is made up of three bytes, which are:

- *****
(1)

(2)

(3)

(4)

(5)

- (1) Space: Invalid data (00100000).
- (2) Range: Range of the first measurement. 2(00000010) ~ 12(00001100).
- (3), (4) Counts: Counts of the first measurement. -1900(1111100010010011) ~ 1900(0000011101101100). This data is made up of two bytes (sixteen bits) and sent in 2's complement.
- (5) Range: Range of the second measurement. Subsequently, each measurement data transmission is made up of three bytes sent in same format as in (2) thru (4) above.

Note

When 4140A Option 101 is set to HSI function, 4140A does not send data terminator (e.g. CR LF) and does not set EOI (End or Identify) line in the HP-IB to "1". Therefore, 4140A is sending current measurement data during the time the 4140A is set to HSI function. If 4140A is set to another function, HSI function is aborted and stops data output. Basic sample program for using HSI function is given in Figure 3-32.

Figure 3-27. Data Output Format of the HSI (High Speed I) Function.

3-97. Programming Guide for 4140A

3-98. Sample programs for HP Model 9825A/9835A Desktop Computer are provided in Figures 3-28 thru 3-32. These programs are listed in Table 3-15.

Note

Specific information for HP-IB programming with the 9825A or 9835A are provided in the 9825A or 9835A programming manuals.

Note

The equipment required for these sample programs include:

1. 4140A pA Meter/DC Voltage Source equipped with Opt. 101 HP-IB Interface.

2. 98034A HP-IB Interface Card.

3. 9825A Desktop Computer with
98210A String-Advanced Programming ROM.
98213A General I/O Extended I/O ROM.

or

9835A Desktop Computer with
98332A General I/O ROM.

Table 3-15. Sample Program Using HP 9825A or 9835A Calculators.

| No. | Figure | Description |
|-----|--------|--|
| 1 | 3-28 | Remote control of pA section and data output when 4140A is set to I function. |
| 2 | 3-29 | Remote control of VS section and parameter output when 4140A is set to I function. |
| 3 | 3-30 | Remote control and data output when 4140A is set to I-V or C-V function. |
| 4 | 3-31 | How to use remote programming code "K". |
| 5 | 3-32 | Remote control and data processing when 4140A is set to High Speed I (HSI) function. |

Sample Program 1

Description:

This program enables remote control of pA Meter section and provides a data output program when 4140A is set to I function. The program has three capabilities which are:

- (1) Control of the pA section of 4140A via HP-IB.
- (2) Trigger of the pA section of 4140A via HP-IB.
- (3) Data output from the 4140A via HP-IB.

9825A Program:

```
0: flt3
1: wrt717,"F1RA1I3T3"
   (1)(2) (3) (4)
2: wrt717,"E"
   (5)
3: red717,A,B
4: dspA,B;prtA,B
5: end
```

- (1) Select code of 98034A.
- (2) Address code of 4140A.
- (3) Sets 4140A to I function.
- (4) Program codes for pA section of the 4140A (refer to Table 3-12).
- (5) This line means the as same as following program:

```
9825A: trg717
9835A: TRIGGER717
```

9835A Program:

```
10: FLOAT3
20: OUTPUT717;"F1RA1I3T3"
   (1)(2) (3) (4)
30: OUTPUT717;"E"
   (5)
40: ENTER717;A,B
50: DISP A,B
60: PRINT A,B
70: END
```

By using string variables, complete output information from the 4140A Opt. 101 is stored by the following program:

9825A Program:

```
0: dimA$[30]
1: wrt717,"F1RA1I3T3"
2: wrt717,"E"
3: red717,A$
4: dspA$;prtA$
5: end
```

9835A Program:

```
10: DIMA$[30]
20: OUTPUT717;"F1RA1I3T3"
30: OUTPUT717;"E"
40: ENTER717;A$
50: DISP A$
60: PRINT A$
70: END
```

Figure 3-28. Sample Program 1 Using 9825A/9835A.

Sample Program 2.

Description:

This program enables remote control of VS section and provides parameter output when 4140A is set to I function. The program has three capabilities which are:

- (1) Control of the VS section of 4140A via HP-IB.
- (2) Auto sweep of the VS section of 4140A via HP-IB.
- (3) Parameter output from the 4140A via HP-IB.

9825A Program:

```

0: dimA$[30]
1: wrt717,"F1A4B1L2M3"
      (1) (2)
2: wrt717,"PS-10,PT10,PE1NPH2;PD.5,PB-50"
      (3) (4) (3) (4)(3)(4)(3)(4) (3) (4) (3)
3: wrt717,"PS"
      (5)
4: red717,A$
      (5)
5: dspA$,prtA$
6: wrt717,"W1"
      (6)
7: end

```

9835A Program:

```

10: DIMA$[30]
20: OUTPUT717;"F1A4B1L2M3"
      (1) (2)
30: OUTPUT717;"PS-10;PT10,PE1NPH2;PD.5,PB-50"
      (3) (4) (3)(4)(3)(4)(3)(4) (3) (4) (3)
40: OUTPUT717;"PS"
      (5)
50: ENTER717;A$
      (5)
60: DISP A$
70: PRINT A$
80: OUTPUT717;"W1"
      (6)
90: END

```

- (1) Sets 4140A to I function.
- (2) Program codes for VS section of the 4140A (refer to Table 3-12).
- (3) Program codes for parameter setting of the 4140A (refer to Table 3-13).
- (4) Parameter terminators for the 4140A.
- (5) Statements on lines 3 and 4 (or 40 and 50) are used to output setting value of the parameter for 4140A. These statements should be continuously programmed.
- (6) Statement for making AUTO START of V SWEEP.

Figure 3-29. Sample Program 2 Using 9825A/9835A.

Sample Program 3.

Description:

This program enables remote control and provides a data output program when 4140A is set to I-V or C-V function. The program has three capabilities which are:

- (1) Control of I-V or C-V measurement of the 4140A via HP-IB.
- (2) Auto sweep of I-V or C-V measurement of the 4140A via HP-IB.
- (3) Data output from the 4140A via HP-IB.

9825A Program:

```

0: dim A$ [100,30]
      (1)
1: wrt 717,"F3RA1I2A1B1L2M3"
2: wrt 717,"PS-1,1;PT1.1.PE.1NPH1;PV1,PB-50"
3: wrt 717,"W1"
4: I→I
5: red 717,A$[I]
6: if A$[I,2,2]="L";I+1→I;jmp -1
      (2)
7: for J=1 to I
8: prt A$[J]
9: next J
10: end

```

9835A Program:

```

10: DIM A$(100)[30]
      (1)
20: OUTPUT 717;"F3RA1I2A1B1L2M3"
30: OUTPUT 717;"PS-1.1;PT1.1,PE.1NPH1;PV1,PB-50"
40: OUTPUT 717;"W1"
50: I→0
60: I=I+1
70: ENTER 717;A$(I)
80: IF A$(I)[2,2]≠"L" THEN 60
      (2)
90: FOR J=1 TO I
100: PRINT A$(J)
110: NEXT J
120: END

```

- (1) Establishes dimensional array parameter that exceeds number of measurement points.
- (2) When the 4140A is set to AUTO SWEEP, second byte of last data is "L" (refer to paragraph 3-87).

Figure 3-30. Sample Program 3 Using 9825A/9835A.

Sample Program 4.

Description:

The remote programming code "K" can be used to recognize 4140A key settings. This program shows how to use "K".

Note

When the I RANGE is set to "RA1 (AUTO)", key setting information for the I RANGE using "K" is "RA1". Therefore, the I RANGE should be set to "RA0 (MANUAL)" for recognizing true I measuring range.

9825A Program:

```
0: dim A$[30]
1: wrt 717,"K"
2: red 717,A$
3: dsp A$;prt A$
4: end
```

9835A Program:

```
10: DIM A$[30]
20: OUTPUT 717;"K"
30: ENTER 717;A$
40: DISP A$
50: PRINT A$
60: END
```

Note

The statements on lines 1 and 2 (or 10 and 20) should be continuously programmed.

Figure 3-31. Sample Program 4 Using 9825A/9835A.

Sample Program 5.

Description:

This program enables remote control and is a data output program when 4140A is set to HSI (High Speed I) function. This program has three capabilities which are:

- (1) Control of the 4140A HSI function via HP-IB.
- (2) High speed I/O control between 4140A and controller via HP-IB.
- (3) Data processing for the 4140A HSI function via HP-IB.

Note

Data output interval of the HSI function is quite short (2.5 to 10ms). Therefore, general I/O programming (9825A: wrt, red, 9835A: OUTPUT, ENTER) can not be used and thus high speed I/O programming must be used for the HSI function. High speed I/O programming with the 9825A and 9835A is slightly different. A basic sample program for HSI is given below, but more specific information for high speed I/O programming with the 9825A or 9835A is provided in the 9825A or 9835A programming manuals.

9825A Program:

```

0: ent "Number ? ",N
      (1)
1: buf "4140A",3N+1,3
      (2)
2: wrt 717,"F4"
      (3)
3: tfr 717,"4140A",3N+1
      (4)
4: rdb("4140A")→S
      (5)
5: fmt 1,f6.3,c2,f2.0,c1
6: for I=1 to N
7: rdb("4140A")→R
      (6)
8: rdb("4140A")→H
      (7)
9: rdb("4140A")→L
      (8)
10: ior(shf(H,-8),L)→C
      (9)
11: wrt 16.1,C/1000,"E-",R,"A"
12: next I
13: end

```

Figure 3-32. Sample Program 5 Using 9825A/9835A (sheet 1 of 2)

9835A Program:

```
10: OPTION BASE 1
20: INPUT "Number ? ",N(1)
30: DIM A$[1000](2)
40: OUTPUT 717;"F4"(3)
50: ENTER 717 BFHS 3*N+1 NO FORMAT;A$(4)
60: S=NUM(A$[1,1])(5)
70: IMAGE D.DDD,AA,DD
80: FOR I=1 TO N
90: R=NUM(A$[3*(I-1)+2,3*(I-1)+2])(6)
100: H=NUM(A$[3*(I-1)+3,3*(I-1)+3])(7)
110: L=NUM(A$[3*(I-1)+4,3*(I-1)+4])(8)
120: C=BINIOR(SHIFT(H,-8),L)(9)
130: PRINT USING 80;C/1000,"E-",R
140: NEXT I
150: END
```

(1) N: Number of data sent.

(2) 9825A: Sets name (4140A), size (3N+1) and type (high speed read/write buffer) of the buffer for high speed I/O.

9835A: Sets name (A\$) and size ($\geq 3N+1$) of string variable for high speed I/O.

(3) Sets 4140A to HSI.

(4) Sends measurement data from 4140A to controller.

(5) Inputs first byte of measurement data from buffer to variable S.

(6) R: Range of first measurement.

(7) H: High byte of count of first measurement.

(8) L: Low byte of count of first measurement.

(9) C: 16 data count bits make up H and C.

Figure 3-32. Sample Program 5 Using 9825A/9835A (sheet 2 of 2)

SECTION IV

PERFORMANCE TESTS

4-1. INTRODUCTION

4-2. The procedures in this section test instrument electrical performance using the specifications of Table 1-1 as the performance standards. All tests can be performed without access to the interior of the instrument. A simpler operational test is included in section III under Self Test. The performance test procedures in this section can also be used to do an incoming inspection of the instrument or to verify whether the instrument meets its specified performance after troubleshooting or making adjustments. If specifications are found to be out of limits, check that controls are properly set, and then proceed to adjustments or troubleshooting.

Note

Allow a 60 minute warm up and stabilization period before conducting any performance test.

4-3. EQUIPMENT REQUIRED

4-4. Equipment required for performance tests is listed in Table 4-1 Recommended Performance Test Equipment. Any equipment that satisfies the critical specifications given in the table may be substituted for the recommended model(s).

Note

Decade resistor and standard resistors should be calibrated by an instrument whose specifications are traceable to NBS, PTB, LNE, NRC, JEMIC or equivalent standards group; or they should be directly calibrated by an authorized calibration organization such as NBS. The calibration cycle should be determined by the stability specification for each resistor.

4-5. TEST RECORD

4-6. Results of the performance tests may be tabulated on the Test Record at the end of these procedures. The Test Record lists all tested specifications and their acceptable limits. The results recorded as incoming inspection can be used for comparison in periodic maintenance and troubleshooting or after repairs or adjustments.

4-7. CALIBRATION CYCLE

4-8. This instrument requires periodic verification of performance. Depending on the use and environmental conditions, the instrument should be checked using the following performance tests at least every six months.

4-9. AUTO SETTING MODES

4-10. The 4140A provides thirteen auto setting modes as given in Table 4-2 for performance tests and adjustments. To set any one of these modes, proceed as follows:

















- (1) Press "Blue",  " to set 4140A to Self Test mode.
- (2) Press "Blue" and select and press desired control key from Table 4-2 to set the mode.
- (3) To cancel any of the above modes, press ",  ".

Table 4-1. Recommended Performance Test Equipment.

| Equipment | Critical Specifications | Recommended Model |
|---------------------------------|---|---|
| DC Voltmeter | Voltage range: 100mV to 1000V f.s. Sensitivity: 1 μ V min. Accuracy : 0.001% Input impedance: >10M Ω Remote Control: via HP-IB | HP 3455A |
| Test Leads | Triaxial (Male) - Triaxial (Male) Cable (1ea) BNC (Male) - BNC (Male) Cable (2ea) | HP 16053A |
| Test Cable | BNC (Male) - Dual Banana Plug Cable | HP 11001A |
| Adapter | BNC T Type Adapter BNC (Female) - Banana Plug Adapter BNC (Male) - Triaxial (Female) Adapter | HP Part No.: 1250-0781 HP 10111A (2ea) TROMPETER AD-BJ77-E3-PL20 |
| Decade Resistor | Range: 10 ² Ω ~ 10 ⁷ Ω Accuracy: 0.01% | GR1433H |
| Standard Resistors | Range: 10 ⁹ Ω ~ 10 ¹³ Ω Accuracy: \pm 0.2% | KEITHLEY 5155 |
| Desktop Computer | for HP-IB Controller | HP 9835A with 98332A |
| HP-IB Interface Card with Cable | Cable Length: approximately 4m | HP 98034A |
| HP-IB Cable | Cable Length: approximately 0.5m | HP 16031D (2ea) |
| Timing Generator | Time Accuracy: \pm 100ns Pulse Width: \geq 1 μ s Rise Time: 50ns Remote Control: via HP-IB | HP 59308A |

Table 4-2. Auto Setting Modes for Performance Tests and Adjustments.

| Mode* | Control key | Description |
|-------|---|---|
| S-1 |  | Both V _A and V _B output 0.00V. With Option 001, both I/C OUTPUT and V _A OUTPUT on the rear panel output 0.000v. |
| S-2 |  | Both V _A and V _B output -0.01V. With Option 001 both I/C OUTPUT and V _A OUTPUT output -0.001V. |
| S-3 |  | Both V _A and V _B output -10.00V. With Option 001, both I/C OUTPUT and V _A OUTPUT output -1.000V. |
| S-4 |  | Both V _A and V _B output +10.00V. With Option 001, both I/C OUTPUT and V _A OUTPUT output +1.000V. |
| S-5 |  | Both V _A and V _B output 0.0V. With Option 001, both I/C OUTPUT and V _A OUTPUT output 0.00V. |
| S-6 |  | Both V _A and V _B output -100.0V. With Option 001, both I/C OUTPUT and V _A OUTPUT output -10.00V. |
| S-7 |  | Both V _A and V _B output +100.0V. With Option 001, both I/C OUTPUT and V _A OUTPUT output +10.00V. |
| S-A |  | Both ZERO and HOLD (pA Meter section control signals) are set to High. |
| S-H |  | ZERO is set to Low and HOLD is set to High. |
| S-0 |  | ZERO is set to High and Hold is set to Low. |
| S-F |  | Both ZERO and HOLD are set to High. |
| S-C |  | Comparator circuit in pA Meter section alternately outputs high or low level signal approximately 400~500 microseconds apart. |
| S-P |  | The pA Meter section is set to measurement mode with internal trigger and auto range. Both V _A and V _B output +1.800V. With Option 001, both I/C OUTPUT and V _A OUTPUT output +1.800V. |

* Mode name is displayed in I·C DISPLAY when its mode is set.

PERFORMANCE TESTS

4-11. VOLTAGE OUTPUT ACCURACY TEST.

4-12. This test verifies DC Voltage Source output voltages for all ranges.

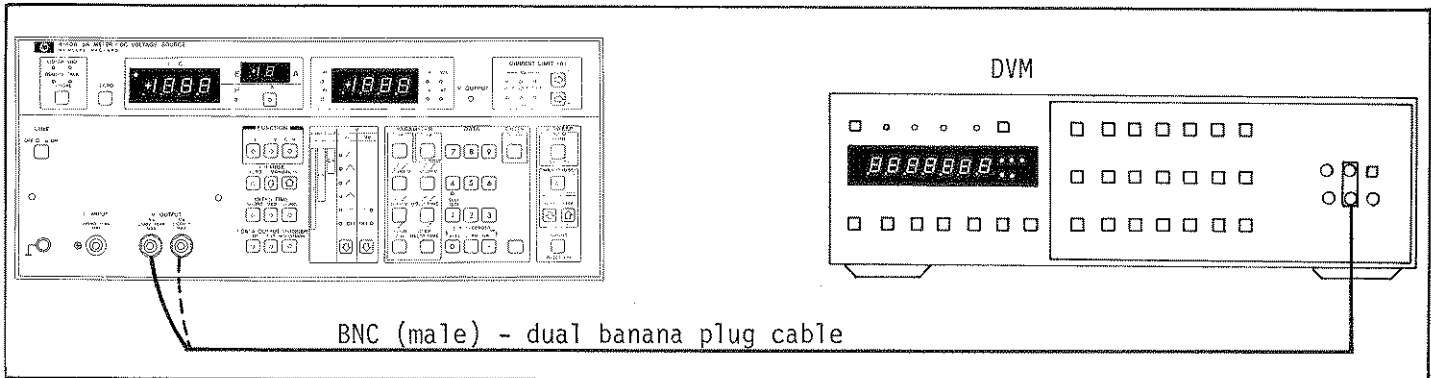

Figure 4-1. Voltage Output Accuracy Test Setup.

EQUIPMENT:

DVM HP 3455A
 BNC (Male) - Dual Banana Plug Cable HP 11001A

PROCEDURE:

1. Connect BNC (Male) - dual banana plug cable between 4140A V_A OUTPUT connector and DVM (see Figure 4-1).

2. Set DVM controls as follows:

FUNCTION DCV
 RANGE AUTO
 HIGH RESOLUTION OFF
 AUTO CAL ON
 GUARD ON
 TRIGGER INTERNAL

3. Set 4140A controls as follows:

FUNCTION I
 V_A == (DC)
 V_B == (DC)
 CURRENT LIMIT (V_A and V_B) 10mA

4. Set PARAMETER (==) to a voltage in Table 4-3.

5. Press SET (==) key and read display output of DVM.

6. Press RESET (==) key.

7. Repeat steps 4 thru 6 and confirm that Table 4-3 is satisfied (change output voltage as appropriate).

8. Connect BNC (male) - dual banana plug cable between 4140A V_B OUTPUT and DVM.

9. Repeat steps 4 thru 7.

PERFORMANCE TESTS

TEST LIMIT:

Table 4-3. Output Voltage Accuracy Test.

| Voltage Setting (V) | Test Limits (V) |
|---------------------|-------------------|
| +100 | +99.80 ~ +100.20 |
| +10 | +9.982 ~ +10.018 |
| +1 | +0.9883 ~ +1.0117 |
| 0 | -0.011 ~ +0.011 |
| -1 | -1.0117 ~ -0.9883 |
| -10 | -10.018 ~ -9.982 |
| -100 | -100.20 ~ -99.80 |

PERFORMANCE TESTS

4-13. CURRENT MEASUREMENT ACCURACY TEST

4-14. This test verifies pA Meter measurement currents for all ranges.

Note

This test uses DC Voltage Source of 4140A. Therefore, Voltage Output Accuracy Test in paragraph 4-11 should be done before this test.

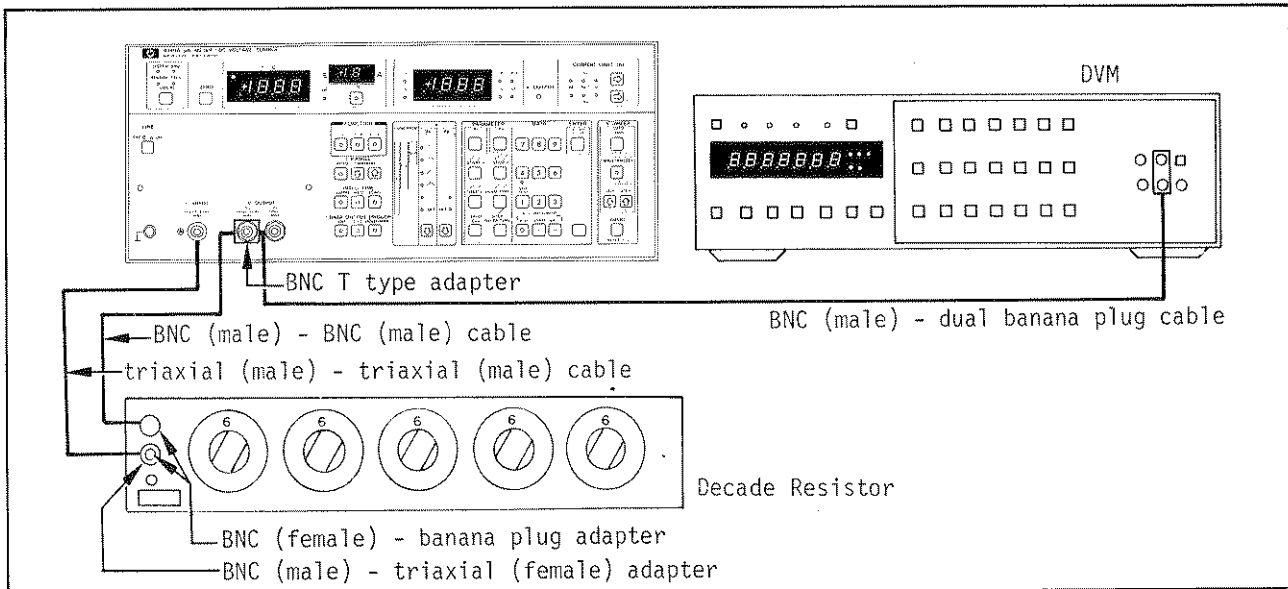

Figure 4-2. Current Measurement Accuracy Test Setup ($10^{-2}A \sim 10^{-7}A$ Ranges).

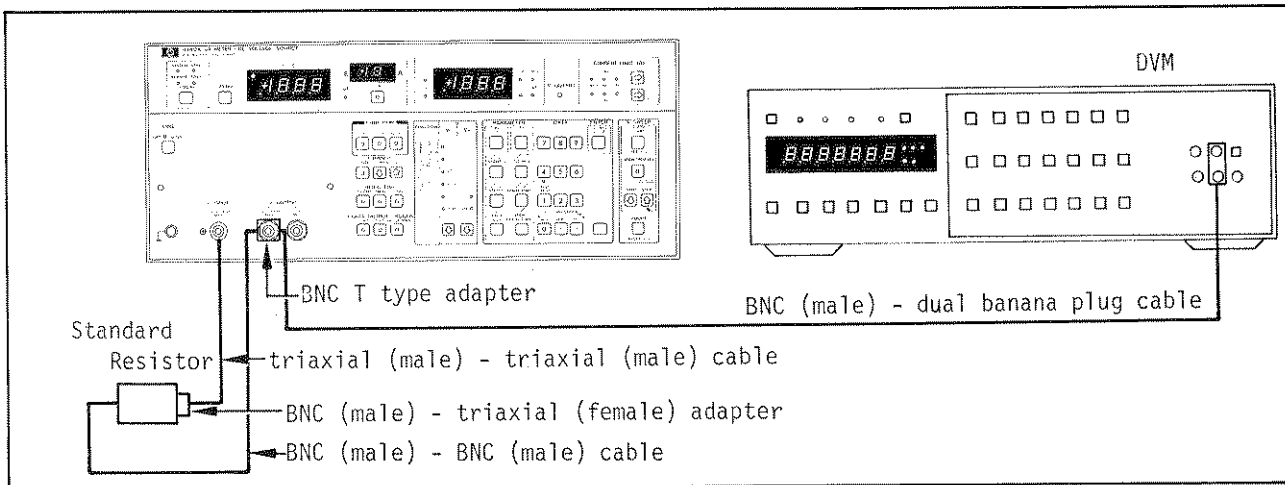

Figure 4-3. Current Accuracy Test Setup ($10^{-8}A \sim 10^{-12}A$ Ranges).

EQUIPMENT:

- Decade Resistor GR1433H
- Standard Resistors KEITHLEY 5155
- BNC T Type Adapter HP Parts No: 1250-0781
- BNC (Female) - Banana Plug Adapter HP 10111A (2ea)
- BNC (Male) - Triaxial (Female) Adapter .. TROMPETER AD-BJ77-E3-PL20

PERFORMANCE TESTS

- Triaxial Cable Part of HP 16053A (HP Part No.: 16053-61002)
- BNC (Male) - BNC (Male) Cable Part of HP 16053A (HP Part No.: 16053-61003)
- BNC (Male) - Dual Banana Plug Cable HP 11001A

PROCEDURE:

1. Connect 4140A, DVM and Standard Resistor as shown in Figure 4-2 or 4-3
2. Set the DVM as follows:

```

FUNCTION ..... DCV
RANGE ..... AUTO
HIGH RESOLUTION ..... OFF
AUTO CAL ..... ON
GUARD ..... ON
TRIGGER ..... INTERNAL
    
```

3. Set the 4140A as follows:

```

FUNCTION ..... I
I RANGE ..... AUTO
INTEG TIME ..... LONG
I DATA OUTPUT TRIGGER ..... INT
VA ..... == (DC)
    
```

4. Set PARAMETER (==) to a voltage in Table 4-4.
5. Push SET (==) key and read display outputs of the DVM and I·C DISPLAY of 4140A.
6. Push RESET (==) key.
7. Repeat steps 1 thru 6 and confirm that Table 4-4 is satisfied (change VA output voltage and standard resistor as appropriate).

TEST LIMIT:

Table 4-4. Current Measurement Accuracy Test.

| Current Measurement Range | VA Output Voltage (V) | Standard Resistor (Ω) | Test Limit |
|--|-----------------------|--|---|
| 10^{-2} 10^{-3} 10^{-4} 10^{-5} 10^{-6} 10^{-7} | 1V | 10^2 10^3 10^4 10^5 10^6 10^7 | S.C.V.* ± 7 counts |
| 10^{-8} 10^{-9} 10^{-10} 10^{-11} 10^{-12} | 10V | 10^9 10^{10} 10^{11} 10^{12} 10^{13} | S.C.V.* ± 22 counts S.C.V.* ± 53 counts S.C.V.* ± 58 counts |

*S.C.V. (Supplied Current Value) = (Standard Resistor Value)/(Measured Voltage of DVM)

PERFORMANCE TESTS

4-15. CURRENT LIMIT TEST

4-16. This test verifies current limit function of DC Voltage Source for all ranges.

Note

This test uses pA Meter of 4140A. Therefore, Current Measurement Accuracy Test in paragraph 4-13 should be done before this test.

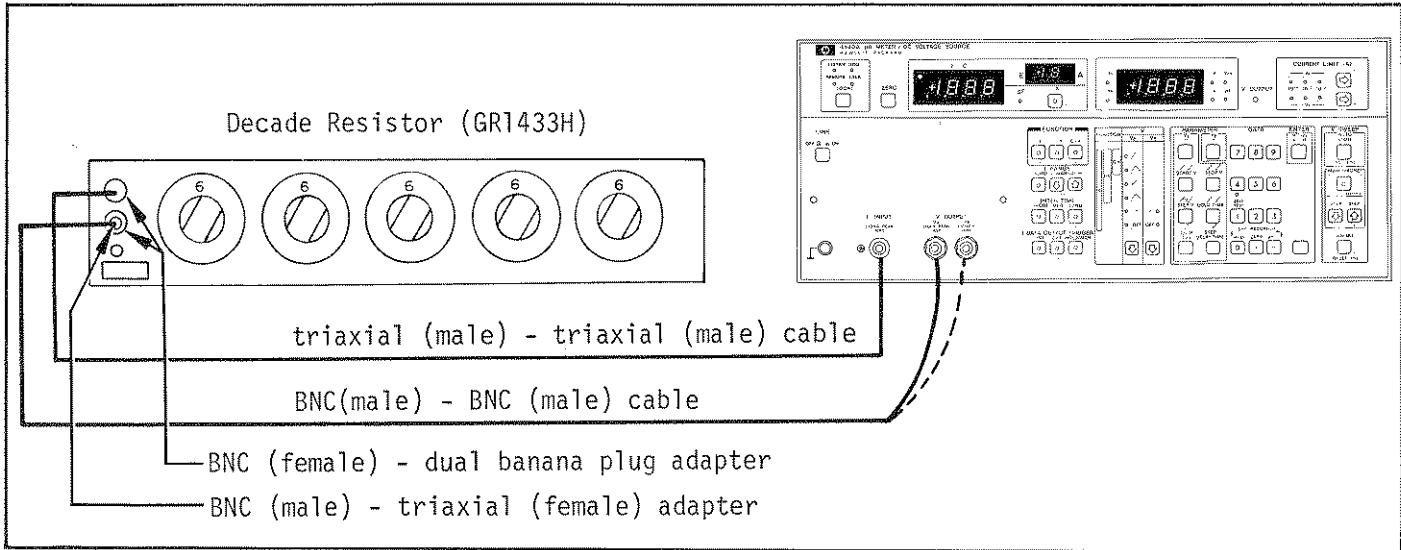

Figure 4-4. Current Limit Test Setup.

EQUIPMENT:

- Decade Resistor GR1433H
- BNC (Female) - Banana Plug Adapter HP 10111A (2ea)
- BNC (Male) - Triaxial (Female) Adapter .. TROMPETER AD-BJ77-E3-PL20
- Triaxial (Male) - Triaxial (Male) Cable . Part of HP 16053A (HP Parts No.: 16053-61002)
- BNC (Male) - BNC (Male) Cable Part of HP 16053A (HP Parts No.: 16053-61003)

PROCEDURE:

1. Connect Decade Resistor between V_A OUTPUT and I INPUT connectors of 4140A as shown in Figure 4-4.
2. Set 4140A as follows:

- FUNCTION I
- I RANGE AUTO
- INTEG TIME LONG
- I DATA OUTPUT TRIGGER INT
- V_A = (DC)
- V_B = (DC)

PERFORMANCE TESTS

3. Set CURRENT LIMIT to a current from Table 4-5.
4. Set PARAMETER (==) to a voltage from Table 4-5.
5. Push SET (==) key and read display output of I·C DISPLAY.
6. Push RESET (==) key.
7. Repeat steps 3 thru 6 and confirm that Table 4-5 (change CURRENT LIMIT and setting of V output voltage as appropriate).
8. Connect Decade Resistor between V_B OUTPUT and I INPUT connectors.
9. Repeat steps 3 thru 7.

TEST LIMIT:

Table 4-5. Current Limit Test.

| Current Limit (A) | Setting V Output Voltage (V) | Test Limit (A) |
|-------------------|------------------------------|--|
| 10^{-2} | +10 | $+0.9 \times 10^{-2} \sim +1.1 \times 10^{-2}$ |
| 10^{-3} | | $+0.9 \times 10^{-3} \sim +1.1 \times 10^{-3}$ |
| 10^{-4} | | $+0.9 \times 10^{-4} \sim +1.1 \times 10^{-4}$ |
| 10^{-2} | -10 | $-1.1 \times 10^{-2} \sim -0.9 \times 10^{-2}$ |
| 10^{-3} | | $-1.1 \times 10^{-3} \sim -0.9 \times 10^{-3}$ |
| 10^{-4} | | $-1.1 \times 10^{-4} \sim -0.9 \times 10^{-4}$ |

PERFORMANCE TESTS

4-17. RAMP WAVE START VOLTAGE ACCURACY TEST.

4-18. This test verifies ramp wave start voltage accuracy for the various combinations of start and stop voltages.

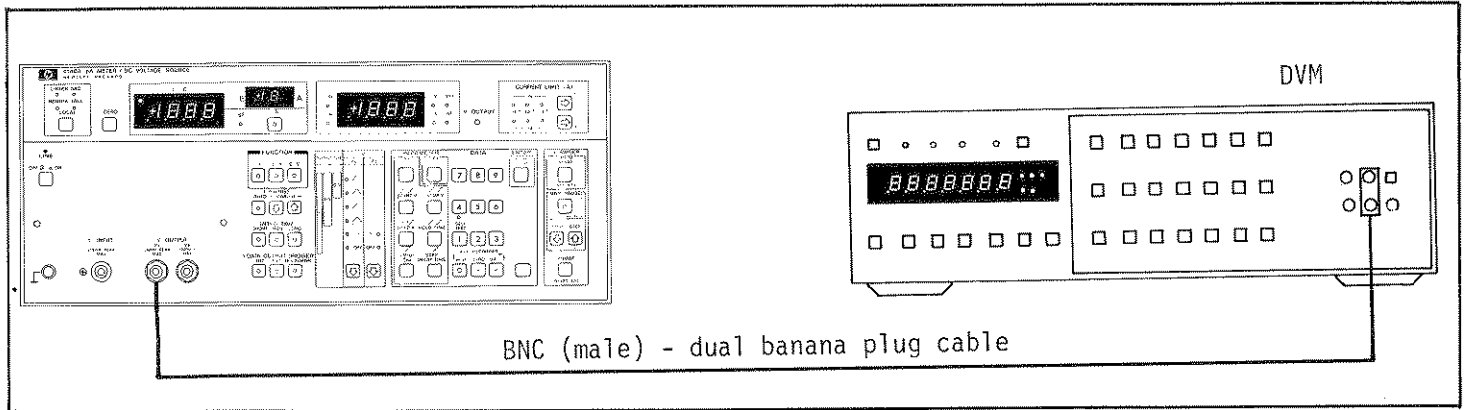

Figure 4-5. Ramp Wave Start Voltage Accuracy Test Setup.

EQUIPMENT:

- DVM HP 3455A
- BNC - Dual Banana Plug Cable HP 11001A

PROCEDURE:

1. Connect BNC (male) - dual banana plug cable between 4140A VA OUTPUT connector and DVM (see Figure 4-5).

2. Set DVM controls as follows:

- FUNCTION DCV
- RANGE AUTO
- HIGH RESOLUTION OFF
- GUARD ON
- TRIGGER INTERNAL



3. Set 4140A controls as follows:

- FUNCTION I
- VA
- VB OFF
- VA CURRENT LIMIT 10mA

4. Set V_A parameter as follows:

- START V a voltage from Table 4-6
- STOP V a voltage from Table 4-6
- STEP V 0.1V
- HOLD TIME 100s
- dV/dt 1V/s

PERFORMANCE TESTS

5. Press "  " key and read display output of DVM.
6. Press "  " key.
7. Repeat steps 4 thru 6 and confirm that Table 4-6 is satisfied (change output voltage as appropriate).

TEST LIMIT:

Table 4-6. RAMP WAVE START VOLTAGE ACCURACY TEST.

| Start Voltage (V) | Stop Voltage (V) | Test Limit (V) |
|---|------------------|---|
| 0.00 +10.00 -10.00 | +5.00 | -0.02 ~ +0.02 +9.98 ~ +10.02 -10.02 ~ -9.98 |
| 0.0 +10.0 -10.0 +100.0 -100.0 | +50.0 | -0.2 ~ +0.2 +9.8 ~ +10.2 -10.2 ~ -9.8 +99.8 ~ +100.2 -100.2 ~ -99.8 |

PERFORMANCE TESTS

4-19. RAMP RATE ACCURACY TEST.

4-20. This test verifies ramp rate accuracy for various combinations of start and stop voltages.

Note

This test requires Option 101 HP-IB Interface as the test is made with the HP-IB system (including HP 9835A Desktop Computer, HP 3455A DVM and HP 59308A Timing Generator, etc.). Therefore, the HP-IB Interface Test in paragraph 4-23 should be done before this test.

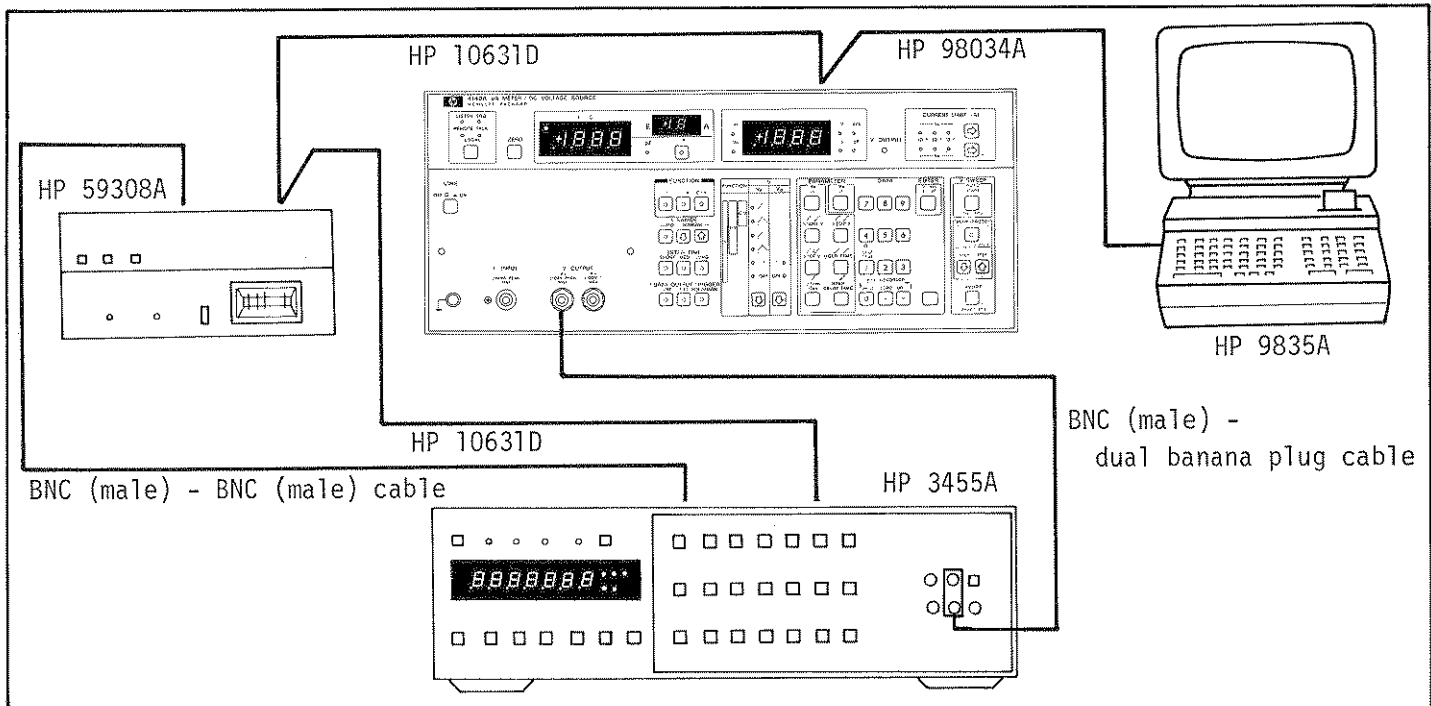

Figure 4-6. Ramp Rate Accuracy Test Setup.

EQUIPMENT:

- | | |
|---|---|
| Desktop Computer | HP 9835A |
| General I/O ROM | HP 98332A |
| HP-IB Interface Card with Cable | HP 98034A |
| HP-IB Cable | HP 10631D (2ea) |
| DVM (with HP-IB Interface capability) ... | HP 3455A |
| Timing Generator | |
| (with HP-IB Interface capability) | HP 59308A |
| BNC (Male) - BNC (Male) Cable | Part of HP 16053A (HP Part No.: 16053-61003) |
| BNC (Male) - Dual Banana Plug Cable | HP 11001A |

PROCEDURE:

1. Turn power switches of 4140A, 9835A, 3455A, and 59308A to OFF.
2. Install Option 101 HP-IB Interface in 4140A. Refer to Option Installation in Section II.

PERFORMANCE TESTS

3. Connect 98034A HP-IB Interface Card with Cable between 9835A I/O slot and 4140A rear panel HP-IB connector as shown in Figure 4-6.
4. Install 98332A ROM in 9835A ROM slot.
5. Set 98034A select code switch dial to select code 7 (using a screw-driver).
6. Set HP-IB addresses of instruments as follows:
 - 4140A: 10001 (17 in binary code).
 - 3455A: 00110 (6 in binary code).
 - 59308A: 10000 (16 in binary code).
7. Connect 4140A, 3455A and 59308A with 10631D HP-IB cables as shown in Figure 4-6.
8. Connect BNC (male) - BNC (male) cable between 59308A OUTPUT connector and 3455A EXT TRIGGER INPUT connector as shown in Figure 4-6.
9. Turn 4140A, 9835A, 3455A and 59308A to ON.
10. Load test program (as shown in Figure 4-7) in controller.
11. Execute the program.
12. Check that 9835A CRT is in accord with Table 4-7 Controller Instructions and Operator Responses and confirm that Table 4-8 is satisfied.

[PROGRAMMING]

| | | |
|-----|---|--|
| 10 | I 4140A RAMP RATE ACCURACY TEST "40RAMP"(21MAY79) | |
| 20 | DIM A(-1:1) | (100) Transfers remote program codes from 9835A to 3455A. |
| 30 | PRINT "RAMP RATE ACCURACY TEST";LIN(1) | |
| 40 | REMOTE 7 | |
| 50 | ABORTIO 7 | |
| 60 | CLEAR 717 | |
| 70 | IMAGE 2D.6D,"V/S" | (110) Transfers remote program codes from 9835A to 59308A. |
| 80 | IMAGE "PS",D,";PT",4D,";PE",.D,";PH",D,";PV",D.3D | |
| 90 | WAIT 2000 | |
| 100 | OUTPUT 706;"F1T2M3A0H1" | |
| 110 | OUTPUT 716;"P100E4R" | (120) Transfers remote program codes from 9835A to 4140A. |
| 120 | OUTPUT 717;"F1RA113T3A1B2L3M3" | |
| 130 | S=0 | |
| 140 | E=.1 | |
| 150 | H=3 | |
| 160 | FOR I=1 TO 4 | (130) Sets START V to 0V. |
| 170 | OUTPUT 706;"R3" | |
| 180 | IF I=1 THEN T=10 | |
| 190 | IF I=2 THEN T=-10 | (140) Sets STEP V to 0.1V. |
| 200 | IF I=3 THEN T=100 | |
| 210 | IF I=4 THEN T=-100 | |
| 220 | FOR K=1 TO 4 | (150) Sets HOLD TIME to 3s. |
| 230 | V=10^(1-K) | |
| 240 | IF K=2 THEN OUTPUT 706;"R2" | |
| 250 | PRINT USING 80;S,T,E,H,V | (180) ~ (210) Sets STOP V. |
| 260 | PAUSE | |
| 270 | OUTPUT 717 USING 80;S,T,E,H,V | (230) Sets dV/dt (Ramp Rate). |
| 280 | OUTPUT 717;"W1" | |
| 290 | WAIT 5000 | |
| 300 | FOR J=-1 TO 1 | |
| 310 | ENTER 706;A(J) | |
| 320 | IF J<1 THEN 350 | (270) Transfers operating parameters from 9835A to 4140A. |
| 330 | PRINT USING 70;A(J)-A(J-1) | |
| 340 | PRINT LIN(1) | |
| 350 | NEXT J | |
| 360 | OUTPUT 717;"W7" | (310) Transfers output data from 3455A to 9835A. |
| 370 | NEXT K | |
| 380 | NEXT I | |
| 390 | OUTPUT 716;"R" | |
| 400 | PRINT "END" | |
| 410 | END | |

Figure 4-7. Ramp Rate Accuracy Test Program Using 9835A.

PERFORMANCE TESTS

Table 4-7. Controller Instructions and Operator Responses for Ramp Rate Accuracy Test Program.

| Controller Instruction | CRT Area | Operator Response |
|---|----------|--|
| RAMP RATE ACCURACY TEST | Print | |
| PSO; PT 10; PE.1; PH3 PV1.000 | | STOP V = 10V, dV/dt = 1V/S. Press "CONTINUE". |
| N.NNNNNV/S | | Confirm that Table 4-8 is satisfied |
| The above two steps are repeated fifteen times more (for each STOP V and dV/dt in Table 4-8). | | |
| END | Print | |

TEST LIMIT:

Table 4-8. Ramp Rate Accuracy Test.

| STOP V (V) | dV/dt (V/s) | Test Limit (V/s) |
|------------|-------------|-----------------------|
| +10 | 1 | +0.99799 ~ +1.00201 |
| | 0.1 | +0.09979 ~ +0.10021 |
| | 0.01 | +0.00997 ~ +0.01003 |
| | 0.001 | +0.000988 ~ +0.001012 |
| -10 | 1 | -1.00201 ~ -0.99799 |
| | 0.1 | -0.10021 ~ -0.09979 |
| | 0.01 | -0.01003 ~ -0.00997 |
| | 0.001 | -0.001012 ~ -0.000988 |
| +100 | 1 | +0.99792 ~ +1.00208 |
| | 0.1 | +0.00990 ~ +0.10028 |
| | 0.01 | +0.00990 ~ +0.01010 |
| | 0.001 | +0.000918 ~ +0.001082 |
| | 1 | -1.00208 ~ -0.99792 |
| -100 | 0.1 | -0.10028 ~ -0.09972 |
| | 0.01 | -0.01010 ~ -0.00990 |
| | 0.001 | -0.001082 ~ -0.000918 |

PERFORMANCE TESTS

4-21. ANALOG OUTPUT ACCURACY TEST (OPTION 001 ONLY).

4-22. This test verifies that the Option 001 Analog Output outputs specified analog output data to external device (e.g. X-Y Recorder).

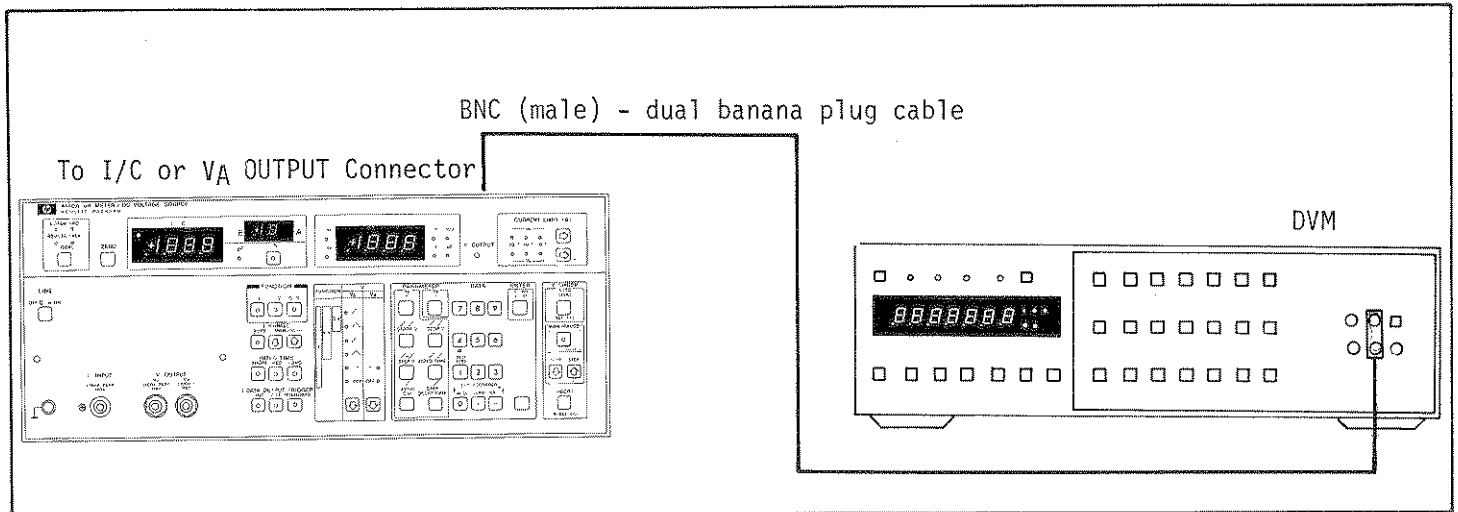

Figure 4-8. Analog Output Accuracy Test Setup.



EQUIPMENT:

- DVM HP 3455A
- BNC (Male) - Dual Banana Plug Cable HP 11001A

PROCEDURE:







1. Connect BNC (male) - dual banana plug cable between the 4140A Option 001 V_A Output connector on rear panel and the DVM (see Figure 4-8).
2. Set the DVM controls as follows:
 - FUNCTION DCV
 - RANGE AUTO
 - HIGH RESOLUTION OFF
 - AUTO CAL ON
 - GUARD ON
 - TRIGGER INTERNAL
3. This test can be made by using auto setting modes of 4140A (refer to paragraph 4-9).
4. Press "Blue", ^{SELF TEST} "I" to set 4140A to Self Test mode.
5. Press "Blue" and a control key from Table 4-9 (to set mode) and read display output of DVM.
6. Repeat step 5 and confirm that the Table 4-9 is satisfied (change auto setting mode as appropriate).

PERFORMANCE TESTS

7. Press "  ,  " to cancel auto setting mode.
8. Connect BNC (male) - dual banana plug cable between the 4140A Option 001 I/C OUTPUT connector on rear panel and DUM.
9. Repeat steps 4 thru 7.

TEST LIMITS:

Table 4-9. Analog Output Accuracy Test.

| Auto Setting Mode | Control Key | Analog Output Setting (V) | Test Limit (V) |
|-------------------|--|---------------------------|-----------------|
| S-1 |  | 0.000 | -0.020 ~ +0.020 |
| S-2 |  | -0.001 | -0.021 ~ +0.019 |
| S-3 |  | -1.000 | -1.025 ~ -0.975 |
| S-4 |  | +1.000 | +0.975 ~ +1.025 |
| S-5 |  | 0.00 | -0.02 ~ +0.02 |
| S-6 |  | -10.00 | -10.07 ~ -9.93 |
| S-7 |  | +10.00 | +9.93 ~ +10.07 |

PERFORMANCE TESTS

4-23. HP-IB INTERFACE TEST (OPTION 101 ONLY)

4-24. This test verifies that the Option 101 HP-IB Interface has the capabilities (as listed in Table 3-11) to correctly communicate between external HP-IB devices and the 4140A through the interface bus cable.

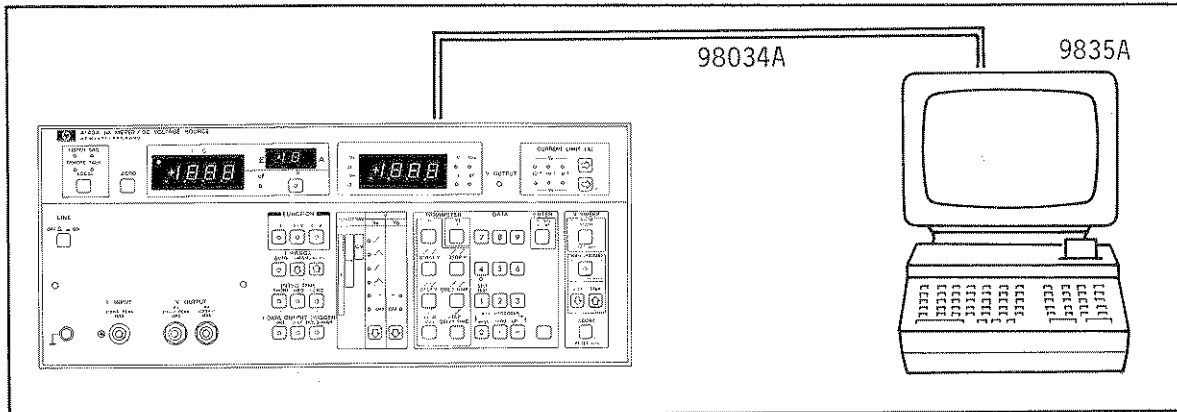

Figure 4-9. HP-IB Interface Test Setup.

EQUIPMENT:

Desktop Computer HP 9835A
 General I/O ROM HP 98332A
 HP-IB Interface Card with cable HP 98034A

PROCEDURE:

1. Turn power switches of both the 4140A and 9835A to OFF.
2. Connect 98034A HP-IB Interface Card with cable between 9835A I/O slot and 4140A rear panel HP-IB connector as shown in Figure 4-9.
3. Install 98332A ROM in 9835A ROM slot.
4. Set 98034A Select Code Switch dial to select code 7 (using a screwdriver).
5. Set 4140A rear panel HP-IB Control Switch to following settings:
 - bit 1~5: 10001 (17 in binary code).
 - bit 6: 0
 - bit 7: 0
6. Connect nothing to I.C INPUT and VS OUTPUT connectors.
7. Turn 4140A and 9835A ON.
8. Load test program (given in Figures 4-10 through 4-14) in calculator.
9. Execute the program.
10. Check that 4140A display, 9835A display, and printed data are in accord with Tables 4-10 through 4-14 Controller Instructions and Operator Responses for each test program.
11. Perform steps 9 thru 11 with respect to individual test programs and verify that 4140A and 9835A correctly communicate through the HP-IB interface.

PERFORMANCE TESTS

TEST PROGRAM 1

[PURPOSE]

This test verifies that 4140A Opt. 101 has the following capabilities:

- (1) Remote/Local Capability
- (2) Local Lockout
- (3) Talk Address Disabled by Listen Address
- (4) Listen Address Disabled

[PROGRAMMING]

| | |
|--|--|
| <pre> 10 I 4140A REMOTE/LOCAL TEST(20MAR79) 20 DIM AS{1} 30 A=0 40 STATUS 717;B 50 PRINT "REMOTE/LOCAL TEST";LIN(1) 60 REMOTE 7 70 OUTPUT 717;"T1" 80 INPUT "LISTEN=1,TALK=0,REMOTE=1",AS 90 IF AS="N" THEN A=1 100 LOCAL 7 110 INPUT "LISTEN=1,TALK=0,REMOTE=0",AS 120 IF AS="N" THEN A=1 130 ABORTIO 7 140 INPUT "LISTEN=0,TALK=0,REMOTE=0",AS 150 IF AS="N" THEN A=1 160 REMOTE 717 170 INPUT "LISTEN=0,TALK=0,REMOTE=1",AS 180 IF AS="N" THEN A=1 190 LOCAL LOCKOUT 7 200 LOCAL 717 210 INPUT "LISTEN=0,TALK=0,REMOTE=0",AS 220 IF AS="N" THEN A=1 230 OUTPUT 717;"T1" 240 INPUT "LISTEN=1,TALK=0,REMOTE=1",AS 250 IF AS="N" THEN A=1 260 IF A=1 THEN 290 270 PRINT "REMOTE/LOCAL TEST PASS";LIN(1) 280 GOTO 300 290 PRINT "REMOTE/LOCAL TEST FAIL";LIN(1) 300 A=0 310 PRINT "LISTEN/TALK TEST";LIN(1) 320 ENTER 717;A,B 330 INPUT "LISTEN=0,TALK=1,REMOTE=1",AS 340 IF AS="N" THEN A=1 350 OUTPUT 717;"T1" 360 INPUT "LISTEN=1,TALK=0,REMOTE=1",AS 370 IF AS="N" THEN A=1 380 IF A=1 THEN 410 390 PRINT "LISTEN/TALK TEST PASS";LIN(1) 400 GOTO 420 410 PRINT "LISTEN/TALK TEST FAIL";LIN(1) 420 PRINT "END";LIN(1) 430 ABORTIO 7 440 END </pre> | <ul style="list-style-type: none"> (40) Clears 4140A SRQ Status Byte. (60) Sets REN (Remote Enable) line of the bus line to "1". Switches selected devices (Interface Select Code 7) to remote operation allowing parameters and device characteristics to be controlled by data message. (70) Addresses 9835A to talk and 4140A to listen. (100) Sets REN to "0". Removes all devices (Interface Select Code 7) from local lockout mode and causes all devices to revert to local. (130) Sets IFC (Interface Clear) line of the bus line to "1". Unconditionally causes control to pass back to 9835A (independent of the device currently in control) and stops all communication. (160) Sets REN to "1". Switches 4140A to remote operation. (190) Prevents the device operator from switching the unit to manual control (200) Causes 4140A to revert to manual control for future parameter modifications (REN remains at "1"). (230) Returns to the status of Step 190. (320) Disables listen address by talk address. (350) Disables talk address by listen address. |
|--|--|

Figure 4-10. HP-IB Interface Test Program 1 Using 9835A.

PERFORMANCE TESTS

Table 4-10. Controller Instructions and Operator Responses for Test Program 1.

| Controller Instruction | CRT Area | Operator Response |
|----------------------------------|----------|--|
| REMOTE/LOCAL TEST | Print | |
| LISTEN = 1, TALK = 0, REMOTE = 1 | Display | If 4140A HP-IB Status Indicators and Controller Instruction are same, press "Y", <input type="text" value="CONTINUE"/> for each step. If not, press "N", <input type="text" value="CONTINUE"/> . |
| LISTEN = 1, TALK = 0, REMOTE = 0 | | |
| LISTEN = 0, TALK = 0, REMOTE = 0 | | |
| LISTEN = 0, TALK = 0, REMOTE = 1 | | |
| LISTEN = 0, TALK = 0, REMOTE = 0 | | |
| LISTEN = 1, TALK = 0, REMOTE = 1 | | |
| REMOTE/LOCAL TEST PASS | Print | If all steps are correct, this message is outputted. |
| REMOTE/LOCAL TEST FAIL | | If any step fails, this message is outputted. |
| LISTEN/TALK TEST | Print | |
| LISTEN = 0, TALK = 1, REMOTE = 1 | Display | If 4140A HP-IB Status Indicators and Controller Instruction are same, press "Y", <input type="text" value="CONTINUE"/> for each step. If not, press "N", <input type="text" value="CONTINUE"/> . |
| LISTEN = 1, TALK = 0, REMOTE = 1 | | |
| LISTEN/TALK TEST PASS | Print | If both steps are correct, this message is outputted. |
| LISTEN/TALK TEST FAIL | | If any step fails, this message is outputted. |
| END | Print | |

PERFORMANCE TESTS

TEST PROGRAM 2

[PURPOSE]

This test verifies that 4140A Opt. 101 has following capabilities:

- (1) Listener
- (2) Device Clear

[PROGRAMMING]

```

10  ! 4140A LISTENER TEST(15MRY79)
20  DIM F$(2),R$(3),I$(2),T$(2),C$(2),A$(2),B$(2),L$(2),M$(2),S$(2),U$(1),X$(50)
30  PRINT "LISTENER TEST";LIN(1)
40  REMOTE 7
50  ABORTIO 7
60  INPUT "FUNCTION ? (F1 thru F4)",F$
70  PRINT F$
80  IF (F$="F1") OR (F$="F4") THEN F1=1
90  IF F$="F2" THEN F2=1
100 IF F$="F3" THEN F3=1
110 INPUT "I RANGE ? (R0,R1,R2 thru R12)",R$
120 PRINT R$
130 INPUT "INTEG TIME ? (I1 thru I3)",I$
140 PRINT I$
150 IF F1=1 THEN INPUT "I DATA OUTPUT TRIGGER ? (T1 thru T3)",T$
160 IF F1=1 THEN PRINT T$
170 IF F3=1 THEN INPUT "pF or % ? (C0 or C1)",C$
180 IF F3=1 THEN PRINT C$
190 IF F1=1 THEN INPUT "VA FUNCTION ? (A1 thru A6)",A$
200 IF F2=1 THEN INPUT "VA FUNCTION ? (A1 thru A4)",A$
210 IF F3=1 THEN INPUT "VA FUNCTION ? (A1 or A2)",A$
220 PRINT A$
230 INPUT "VB FUNCTION ? (B1 or B2)",B$
240 PRINT B$
250 INPUT "VA CURRENT LIMIT ? (L1 thru L3)",L$
260 PRINT L$
270 INPUT "VB CURRENT LIMIT ? (M1 thru M3)",M$
280 PRINT M$
290 INPUT "CONTROL MASK ? (D0 or D7)",D$
300 PRINT D$
310 INPUT "SELF TEST ? (S0 or S1)",S$
320 PRINT S$
330 OUTPUT 717;F$,R$,I$,T$,C$,A$,B$,L$,M$,D$,S$
340 GOSUB K
350 INPUT "Is key status true ? (Y or N)",U$
360 IF U$="N" THEN 390
370 PRINT "LISTENER TEST PASS";LIN(1)
380 GOTO 400
390 PRINT "LISTENER TEST FAIL";LIN(1)
400 PRINT "DEVICE CLEAR TEST";LIN(1)
410 CLEAR 717
420 GOSUB K
430 INPUT "Is key status true ? (Y or N)",U$
440 IF U$="N" THEN 470
450 PRINT "DEVICE CLEAR TEST PASS";LIN(1)
460 GOTO 480
470 PRINT "DEVICE CLEAR TEST FAIL";LIN(1)
480 PRINT "END";LIN(1)
490 END
500 K: OUTPUT 717;"K"
510 ENTER 717;X$
520 PRINT X$;LIN(1)
530 RETURN

```

- (330) Transfers remote program codes from 9835A to 4140A.
- (410) Initializes device-dependent functions to a predefined state.
- (510) Transfers outputted data from 4140A to 9835A.

Figure 4-11. HP-IB Interface Test Program 2 Using 9835A.

PERFORMANCE TESTS

Table 4-11. Controller Instructions and Operator Responses for Test Program 2.

| Controller Instruction | CRT Area | Operator Response |
|--------------------------------------|----------|---|
| LISTENER TEST | Print | |
| FUNCTION? (F1 thru F4) | Display | Input HP-IB program code in each step (see Table 3-12). Example: F3, R10, I2, C1, A2, B1, L2, M3, D2, S0 F3 C-V R10 10 ⁻¹⁰ A I2 MED C1 % A2  B1 == L2 10 ⁻³ A M3 10 ⁻⁴ A D2 See Table 3-12 S0 OFF * This step is only done when FUNCTION is set to I or HSI (High Speed I function). ** This step is only done when FUNCTION is set to I-V. *** This step is only done when FUNCTION is set to C-V. |
| F3 | Print | |
| I RANGE? (RA0, RA1, R02 thru R12) | Display | |
| R10 | Print | |
| INTEG TIME? (I1 thru I3) | Display | |
| I2 | Print | |
| I DATA OUTPUT TRIGGER? (T1 thru T3)* | Display | |
| T1* | Print | |
| pF or %? (C0 or C1)*** | Display | |
| C1*** | Print | |
| VA FUNCTION? (A1 thru A6)* | Display | |
| VA FUNCTION? (A1 thru A4)** | | |
| VA FUNCTION? (A1 or A2)*** | | |
| A2 | Print | |
| VB FUNCTION? (B1 or B2) | Display | |
| B1 | Print | |
| VA CURRENT LIMIT? (L1 thru L3) | Display | |
| L2 | Print | |
| VB CURRENT LIMIT? (M1 thru M3) | Display | |
| M3 | Print | |
| CONTROL MASK? (D0 or D7) | Display | |
| D2 | Print | |
| SELF TEST? (S0 or S1) | Display | |
| S0 | Print | |
| F3R10I2T1C1A2B1L2M3D2S0 | Print | This is the key status data of 4140A when it accepts input remote program codes from controller. |
| Is key status true? (Y or N) | Display | If input remote codes and outputted key status data are same, press "Y", <input type="button" value="CONTINUE"/> . If not, press "N", <input type="button" value="CONTINUE"/> . |
| LISTENER TEST PASS | Print | |
| LISTENER TEST FAIL | | |
| DEVICE CLEAR TEST | Print | This is the key status data of 4140A when it accepts SDC (Selected Device Clear) command from controller. |
| F1R1I3T1C0A3B2L1M1D0S0 | | |
| Is key status true? (Y or N) | Display | If outputted key status data and initial control settings (F1R1I3T1C0A3B2L1M1D0S0) are same, press "Y", <input type="button" value="CONTINUE"/> . If not, press "N", <input type="button" value="CONTINUE"/> . |
| DEVICE CLEAR TEST PASS | Print | |
| DIVICE CLEAR TEST FAIL | | |
| END | Print | |

PERFORMANCE TESTS

TEST PROGRAM 3

[PURPOSE]

This test verifies that 4140A Opt. 101 has following capabilities:

- (1) Talker
- (2) Device Trigger

[PROGRAMMING]

```
10  I 4140A TALKER TEST(20MAR79)
20  PRINT "TALKER TEST";LIN(1)
30  PRINT "DATA OUTPUT TEST"
40  DIM A$(30),B$(30),C$(30),F$(1)
50  STATUS 717;C
60  LOCAL 7
70  FLOAT 5
80  REMOTE 7
90  ABORTIO 7
100 CLEAR 717
110 OUTPUT 717;"F111T3A5"
120 OUTPUT 717;"PA-10"
130 OUTPUT 717;"W1E"
140 ENTER 717;A,B
150 PRINT A,B;LIN(1)
160 INPUT "Is output data true ? (Y or N)",F$
170 IF F$="N" THEN 200
180 PRINT "DATA OUTPUT TEST PASS";LIN(1)
190 GOTO 210
200 PRINT "DATA OUTPUT TEST FAIL";LIN(1)
210 PRINT "COMPLETE DATA OUTPUT TEST"
220 OUTPUT 717;"E"
230 ENTER 717;A$
240 PRINT A$;LIN(1)
250 INPUT "Is output data true ? (Y or N)",F$
260 IF F$="N" THEN 290
270 PRINT "COMPLETE DATA OUTPUT TEST";LIN(1)
280 GOTO 300
290 PRINT "COMPLETE DATA OUTPUT TEST PASS";LIN(1)
300 PRINT "DEVICE TRIGGER TEST"
310 TRIGGER 717
320 ENTER 717;B$
330 PRINT B$;LIN(1)
340 INPUT "Is output data true ? (Y or N)",F$
350 IF F$="N" THEN 380
360 PRINT "DEVICE TRIGGER TEST PASS";LIN(1)
370 GOTO 390
380 PRINT "DEVICE TRIGGER TEST FAIL";LIN(1)
390 PRINT "PARAMETER OUTPUT TEST"
400 OUTPUT 717;"PA"
410 ENTER 717;C$
420 PRINT C$;LIN(1)
430 INPUT "Is output data true ? (Y or N)",F$
440 IF F$="N" THEN 470
450 PRINT "PARAMETER OUTPUT TEST PASS";LIN(1)
460 GOTO 480
470 PRINT "PARAMETER OUTPUT TEST FAIL";LIN(1)
480 PRINT "END"
490 END
```

(310) Causes 4140A to simultaneously initiate a device - dependent action.

Figure 4-12. HP-IB Interface Test Program 3 Using 9835A.

PERFORMANCE TESTS

Table 4-12. Controller Instructions and Operator Responses for Test Program 3.

| Controller Instruction | CRT Area | Operator Response |
|--------------------------------|----------|--|
| TALKER TEST | Print | |
| DATA OUTPUT TEST | Print | |
| ±N.NNNE-NN ±NNN.NN | Print | |
| Is output data true? (Y or N) | Display | If outputted data and values of I.C DISPLAY and VS DISPLAY are same, press "Y", CONTINUE ". If not, press "N", CONTINUE ". |
| DATA OUTPUT TEST PASS | Print | |
| DATA OUTPUT TEST FAIL | | |
| COMPLETE DATA OUTPUT TEST | Print | |
| XX±N.NNNE-NN,A±NNN.NN | Print | |
| Is output data true? (Y or N) | Display | If outputted data is true, press "Y", CONTINUE ". If not, press "N", CONTINUE ". |
| COMPLETE DATA OUTPUT TEST PASS | Print | |
| COMPLETE DATA OUTPUT TEST FAIL | | |
| DEVICE TRIGGER TEST | Print | |
| XX±N.NNNE-NN,A±NNN.NN | Print | |
| Is output data true? (Y or N) | Display | If outputted data is true, press "Y", CONTINUE ". If not, press "N", CONTINUE ". |
| DEVICE TRIGGER TEST PASS | Print | |
| DEVICE TRIGGER TEST FAIL | | |
| PARAMETER OUTPUT TEST | Print | |
| XX±NNNN.NNN | Print | |
| Is output data true? (Y or N) | Display | If outputted data is true, press "Y", CONTINUE ". If not, press "N", CONTINUE ". |
| PARAMETER OUTPUT TEST PASS | Print | |
| PARAMETER OUTPUT TEST FAIL | | |
| END | Print | |

PERFORMANCE TESTS

TEST PROGRAM 4

[PURPOSE]

This test program verifies that 4140A Opt. 101 has following capabilities:

- (1) Service Request
- (2) Serial Poll

[PROGRAMMING]

```
10  I 4140A SRQ TEST(15MAY79)
20  PRINT "SRQ TEST";LIN(1)
30  FIXED 0
40  ON INT #7 GOSUB Srq
50  REMOVE 7
60  ABORTIO 7
70  CLEAR 717
80  STATUS 717;A
90  A=0
100 PRINT "DATA READY"
110 OUTPUT 717;"T3D7E"
120 GOSUB Loop
130 A=0
140 PRINT "SELF TEST END"
150 OUTPUT 717;"S1"
160 OUTPUT 717;"S0"
170 GOSUB Loop
180 A=0
190 PRINT "SYNTAX ERROR"
200 OUTPUT 717;"DOS015"
210 GOSUB Loop
220 A=0
230 PRINT "PARAMETER OVER FLOW ERROR"
240 OUTPUT 717;"PA1000;"
250 GOSUB Loop
260 A=0
270 PRINT "ILLEGAL ERROR"
280 OUTPUT 717;"W1"
290 GOSUB Loop
300 PRINT "END"
310 END
320 Loop: CONTROL MASK 7;128
330 CARD ENABLE 7
340 IF BIT(A,0)=1 THEN 380
350 IF BIT(A,2)=1 THEN 380
360 IF BIT(A,3)=1 THEN 380
370 GOTO Loop
380 PRINT A;LIN(1)
390 RETURN
400 Srq: STATUS 717;A
410 IF BIT(A,6)=1 THEN 430
420 PRINT "OTHER DEVICE SRQ";LIN(1)
430 RETURN
```

- (40) Designates label (SRQ) for service routing to be performed when an instrument is set by a device on select code 7 bus line.
- (320)~(330) Labels Loop. Enables service request to be sent from device on select code 7 bus line. Checks status of SRQ line on the bus line.

Figure 4-13. HP-IB Interface Test Program 4 Using 9835A.

PERFORMANCE TESTS

Table 4-13. Controller Instructions and Operator Responses for Test Program 4.

| Controller Instruction | CRT Area | Operator Response |
|---------------------------|----------|---|
| SRQ TEST | Print | |
| DATA READY | | Outputted SRQ Status Byte data should be 65 (=01000001). |
| 65 | | |
| SELF TEST END | | Outputted SRQ Status Byte data should be 68 (=01000100). |
| 68 | | |
| SYNTAX ERROR | | Outputted SRQ Status Byte data should be 72 (=010010000). |
| 72 | | |
| PARAMETER OVER FLOW ERROR | | Outputted SRQ Status Byte data should be 72 (=010010000). |
| 72 | | |
| ILLEGAL ERROR | | Outputted SRQ Status Byte data should be 72 (=01001000). |
| 72 | | |
| END | | |

PERFORMANCE TESTS

TEST PROGRAM 5

[PURPOSE]

This test verifies 4140A HP-IB Control Switch has the following capabilities:

- (1) Address
- (2) Output Format B

[PROGRAMMING]

```
10  ! 4140A HP-IB CONTROL SWITCH TEST(15MAY79)
20  PRINT "HP-IB CONTROL SWITCH TEST";LIN(1)
30  DIM A$(7),B$(1),C$(30),D$(30)
40  PRINT "ADDRESS TEST"
50  L=0
60  FOR I=1 TO 6
70  IF I=1 THEN A=700
80  IF I=1 THEN A$="0000000"
90  IF I=2 THEN A=701
100 IF I=2 THEN A$="0000001"
110 IF I=3 THEN A=702
120 IF I=3 THEN A$="0000010"
130 IF I=4 THEN A=704
140 IF I=4 THEN A$="0000100"
150 IF I=5 THEN A=708
160 IF I=5 THEN A$="0001000"
170 IF I=6 THEN A=716
180 IF I=6 THEN A$="0010000"
190 DISP "Turn off 4140A"
200 BEEP
210 PAUSE
220 DISP "Set HP-IB control switch to ",A$
230 BEEP
240 PAUSE
250 DISP "Turn on 4140A"
260 BEEP
270 PAUSE
280 WAIT 1000
290 OUTPUT A;"11"
300 INPUT "LISTEN=1,TALK=0,REMOTE=1",B$
310 IF B$="N" THEN L=1
320 ENTER A;M,N
330 INPUT "LISTEN=0,TALK=1,REMOTE=1",B$
340 IF B$="N" THEN L=1
350 NEXT I
360 IF L=1 THEN 390
370 PRINT "ADDRESS TEST PASS";LIN(1)
380 GOTO 400
390 PRINT "ADDRESS TEST FAIL";LIN(1)
400 PRINT "OUTPUT DATA FORMAT B TEST"
410 DISP "Turn off 4140A"
420 BEEP
430 PAUSE
440 DISP "Set HP-IB control switch to 0110001"
450 BEEP
460 PAUSE
470 DISP "Turn on 4140A"
480 BEEP
490 PAUSE
500 WAIT 1000
510 ENTER 717;C$,D$
520 PRINT C$
530 PRINT D$
540 INPUT "Is output data true ? (Y or N)",B$
550 IF B$="N" THEN 580
560 PRINT "OUTPUT DATA FORMAT B TEST PASS";LIN(1)
570 GOTO 620
580 PRINT "OUTPUT DATA FORMAT B TEST FAIL";LIN(1)
590 DISP "Turn off 4140A"
600 BEEP
610 PAUSE
620 DISP "Set HP-IB control switch to 0010001"
630 BEEP
640 PAUSE
650 PRINT "END"
660 END
```

Figure 4-14. HP-IB Interface Test Program 5 Using 9835A.

PERFORMANCE TESTS

Table 4-14. Controller Instructions and Operator Responses for Test Program 5.

| Controller Instruction | CRT Area | Operator Response |
|---|----------|--|
| HP-IB CONTROL SWITCH TEST | Print | |
| ADDRESS TEST | Print | |
| Turn off 4140A | Display | Turn the 4140A OFF and press " <input type="text" value="CONTINUE"/> ". |
| Set HP-IB control switch to 0000000 | | Set HP-IB Control Switch to "0000000" and press " <input type="text" value="CONTINUE"/> ". |
| Turn on 4140A | | Turn the 4140A ON and Press " <input type="text" value="CONTINUE"/> ". |
| LISTEN = 1, TALK = 0, REMOTE = 1 LISTEN = 0, TALK = 1, REMOTE = 1 | | If 4140A HP-IB Status Indicators and Controller Instruction are same, press " <input type="text" value="Y"/> ", <input type="text" value="CONTINUE"/> " in each step. If not, press " <input type="text" value="N"/> ", <input type="text" value="CONTINUE"/> ". |
| The above five steps are repeated five more times (for each of the following addresses): (1) 0000001 (2) 0000010 (3) 0000100 (4) 0001000 (5) 0010000 | | |
| ADDRESS TEST PASS | Print | If all steps are correct, this message is outputted. |
| ADDRESS TEST FAIL | | If any step fails, this message is outputted. |
| OUTPUT DATA FORMAT B TEST | Print | |
| Turn off 4140A | Display | Turn the 4140A OFF and press " <input type="text" value="CONTINUE"/> ". |
| Set HP-IB control switch to 0110001 | | Set HP-IB Control switch to "0110001" and press " <input type="text" value="CONTINUE"/> ". |
| Turn on 4140A | | Turn the 4140A ON and press " <input type="text" value="CONTINUE"/> ". |
| XXN.NNN-NN A±NNN.NN | Print | |
| Is output data true? (Y or N) | Display | If outputted data is true, press " <input type="text" value="Y"/> ", <input type="text" value="CONTINUE"/> ". If not, press " <input type="text" value="N"/> ", <input type="text" value="CONTINUE"/> ". |
| OUTPUT DATA FORMAT B TEST PASS | Print | |
| OUTPUT DATA FORMAT B TEST FAIL | | |
| Turn off 4140A | Display | Turn the 4140A OFF and press " <input type="text" value="CONTINUE"/> ". |
| Set HP-IB Control switch to 0010001 | | Set HP-IB Control Switch to "0010001" and press " <input type="text" value="CONTINUE"/> ". |
| END | | |

PERFORMANCE TEST RECORD

| Hewlett-Packard Model 4140A pA METER/DC VOLTAGE SOURCE Serial No. | | Tested by Date | | |
|--|---|---|--------|---|
| Paragraph Number | TEST | Results | | |
| | | Minimum | Actual | Maximum |
| 4-11 | VOLTAGE OUTPUT ACCURACY TEST Voltage Setting +100V +10V +1V 0V -1V -10V -100V | +99.80V +9.982V 0.9883V -0.011V -1.0117V -10.018V -100.20V | | +100.20V +10.018V +1.0117V 0.011V -9.883V -9.982V -99.80V |
| 4-13. | CURRENT MEASUREMENT ACCURACY TEST Current Measurement Range Setting 10 ⁻² A 10 ⁻³ A 10 ⁻⁴ A 10 ⁻⁵ A 10 ⁻⁶ A 10 ⁻⁷ A 10 ⁻⁸ A 10 ⁻⁹ A 10 ⁻¹⁰ A 10 ⁻¹¹ A 10 ⁻¹² A | S.C.V. -7counts S.C.V. -7counts S.C.V. -7counts S.C.V. -7counts S.C.V. -7counts S.C.V. -7counts S.C.V. -7counts S.C.V. -7counts S.C.V. -7counts S.C.V. -22counts S.C.V. -53counts S.C.V. -58counts | | S.C.V. +7counts S.C.V. +7counts S.C.V. +7counts S.C.V. +7counts S.C.V. +7counts S.C.V. +7counts S.C.V. +7counts S.C.V. +7counts S.C.V. +7counts S.C.V. +22counts S.C.V. +53counts S.C.V. +58counts |
| 4-15 | CURRENT LIMIT TEST Current Limit Setting +10 ⁻² A +10 ⁻³ A +10 ⁻⁴ A -10 ⁻² A -10 ⁻³ A -10 ⁻⁴ A | +0.9x10 ⁻² A +0.9x10 ⁻³ A +0.9x10 ⁻⁴ A -1.1x10 ⁻² A -1.1x10 ⁻³ A -1.1x10 ⁻⁴ A | | +1.1x10 ⁻² A +1.1x10 ⁻³ A +1.1x10 ⁻⁴ A -0.9x10 ⁻² A -0.9x10 ⁻³ A -0.9x10 ⁻⁴ A |
| 4-17 | RAMP WAVE START VOLTAGE ACCURACY TEST Start Voltage Setting 0.00V +10.00V | -0.02V +9.98V | | +0.02V +10.02V |

PERFORMANCE TEST RECORD

| Paragraph Number | TEST | Results | | |
|------------------|---|--------------|--------|--------------|
| | | Minimum | Actual | Maximum |
| 4-17 | RAMP WAVE START VOLTAGE ACCURACY TEST (Continued) | | | |
| | -10.00V | -10.02V | | -9.98V |
| | 0.0V | -0.2V | | +0.2V |
| | +10.0V | +9.8V | | +10.2V |
| | -10.0V | -10.2V | | -9.8V |
| | +100.0V | +99.8V | | +100.2V |
| | -100.0V | -100.2V | | -99.8V |
| 4-19 | RAMP RATE ACCURACY TEST | | | |
| | dV/dt Setting | | | |
| | STOP V = +10V | | | |
| | 1V/s | +0.99799V/s | | +1.00201V/s |
| | 0.1V/s | +0.09979V/s | | +0.10021V/s |
| | 0.01V/s | +0.00997V/s | | +0.01003V/s |
| | 0.001V/s | +0.000998V/s | | +0.001012V/s |
| | STOP V = -10V | | | |
| | 1V/s | -1.00201V/s | | -0.99799V/s |
| | 0.1V/s | -0.10021V/s | | -0.09979V/s |
| | 0.01V/s | -0.01003V/s | | -0.00997V/s |
| | 0.001V/s | -0.001012V/s | | -0.000988V/s |
| | STOP V = +100V | | | |
| | 1V/s | +0.99792V/s | | +1.00208V/s |
| | 0.1V/s | +0.09972V/s | | +0.10028V/s |
| | 0.01V/s | +0.00990V/s | | +0.01010V/s |
| | 0.001V/s | +0.000918V/s | | +0.001082V/s |
| | STOP V = -100V | | | |
| | 1V/s | -1.00208V/s | | -0.99792V/s |
| | 0.1V/s | -0.10028V/s | | -0.09972V/s |
| | 0.01V/s | -0.01010V/s | | -0.00990V/s |
| | 0.001V/s | -0.001082V/s | | -0.000918V/s |
| 4-21 | ANALOG OUTPUT ACCURACY TEST (OPTION 001 ONLY) | | | |
| | Analog Output Setting | | | |
| | 0.000V | -0.020V | | +0.020V |
| | -0.001V | -0.021V | | +0.019V |
| | -1.000V | -1.025V | | -0.975V |
| | +1.000V | +0.975V | | -0.975V |
| | 0.00V | -0.02V | | +0.002V |
| | -10.00V | -10.07V | | -9.93V |
| | +10.00V | +9.93V | | +10.07V |

